

General Guidelines For All ProPanels:

1. Whenever moving ProPanels, transport them with the shortest dimension in the vertical position to reduce potential stress or breaking of the fiberglass. Do not move ProPanels parallel to the floor without additional support.
2. If light colored fabrics are used, it may be a good idea to wear white cotton gloves so dirt, grease or grime from the skin is not transferred to the fabric.
3. Pre-position ProPanels with a laser level (preferred), hand level or chalk line to ensure uniform installation. If ProPanels are being placed directly up against one another, use the first ProPanel as a reference point for adjoining ProPanels to be installed.
4. Make sure the wall has a completely flat surface. Shim the ProPanels if necessary to create a uniform front surface.

NOTE: Impaling clips are used for wall, vertical corner and horizontal corner installations only. For mounting or suspending ProPanels from the ceiling, use Auralex Snap-On Anchors or Auralex Cloud Anchors, respectively.

Installation Notes When Using Impaling Clips:

1. Mark the intended location of each panel on the wall.
2. Fasten impaling clips to the wall using drywall screws, concrete anchors or shots and pins for concrete block or pre-cast concrete walls using the guide below.

ProPanel Size (1" or 2" thick)

Number of Clips

NOTE: 6 lb per cu ft density ProPanels over 2" thick must also use Tubetak Pro adhesive for installation.

2'x2'

2

2'x4'

2

4'x4'

4

4'x6'

6

4'x8'

6

3. Shim the clips as necessary to ensure a flat mounting surface and the front edge of the ProPanel is flush with adjoining ProPanels.
4. Do not apply excessive pressure to a single or multiple small locations on the ProPanel so as to crush or dent the fiberglass core.
5. This installation method will leave a 3/4" reveal between the top of the ProPanel and the ceiling.

Note On Adhesives:

- The use of adhesives is highly suggested on all ProPanel thicknesses for a secure permanent installation, though it is only mandatory for ProPanels thicker than 2" or when mounting to an uneven, non-flat wall surface.
- Use ONLY water-based, heavy bodied adhesives, such as Auralex's Tubetak Pro™.
- Apply the adhesive liberally to the fiberglass in 4" x 4" sized areas, but do not apply any adhesive within 3" from the edge of the ProPanel. We do **NOT** recommend applying adhesive directly to the impaling clip points as doing so may prevent the clip from properly engaging the fiberglass. Applying adhesive to the flat face of the impaling clip will ensure a more secure installation.
- To ensure that the panel fully engages the impaling clip, apply firm and even downward pressure to panel.

Recommended Additional Installation Materials

- | | |
|--------------------|---|
| • Power Drill | • Tape measure |
| • Carpenters Level | • Small ladder (<i>depending on ceiling height</i>) |
| • Pencil | • 160 .75"-1" drywall screws |
| • Straight Edge | |

Auralex® Acoustics, Inc.

1-800-959-3343 | 317-842-2600 | Auralex.com
9955 Westpoint Drive, Suite 101, Indianapolis IN USA 46256

937-1212.ProPanel User Guide (01/12/2020 - 5:23 PM)

ProPanels - Straight or Beveled

- 1 Mark vertical and horizontal lines indicating placement of the ProPanel. (Images shown for 24" X 48" panels).
- 2 Install impaling clips 4" in from the vertical lines to avoid fabric return. For ProPanels using 2 impaling clips, install impaling clips near opposing corners.
- 3 Start the ProPanel 3/4" above its intended final height and press downward at a 45° angle until the ProPanel is flush with the wall.

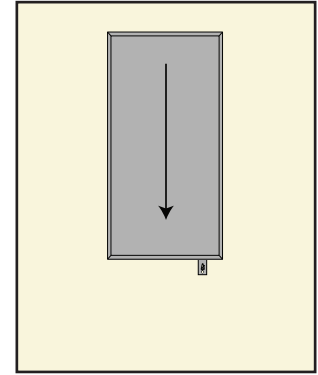
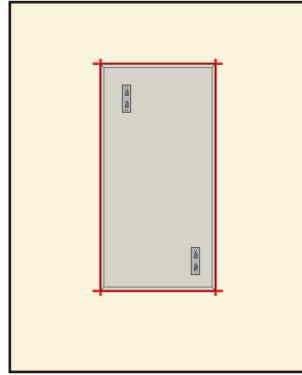
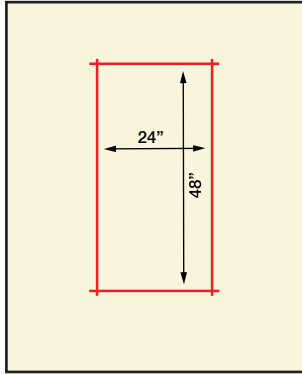

Corner/Bass Trap

- 1 Mark lines on the walls and/or ceiling, near the target corner, using the measurements below. For all installations ensure that the fabric return on the rear of the panel, near the corners, is not greater than 2" to prevent interference with the impaling points.

- Use 8 1/4" for 16" wide SonoSuede Corner Traps
- Use 13 7/8" for 24" wide M224 ProPanels
- Use 16 5/8" for 24" wide B224 or S224 ProPanels

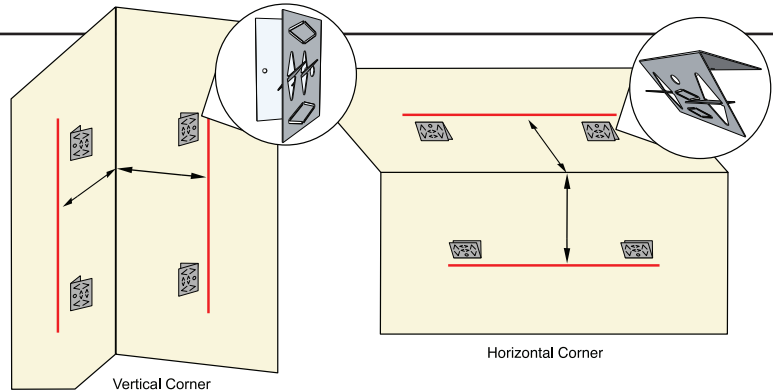

- 2 Determine clip orientation (left/right or wall/ceiling) and use a felt tip marker to indicate clip position and which side will face up. Twist out the top facing tips of the impaling points to a 45° angle relative to the clip face.

Use the smaller set of points for vertical corners and the larger points for horizontal corners (these will be parallel to the floor with the clips oriented correctly).

Align the front fold of the clip with your marked lines leaving some space from the panel end for placement flexibility.

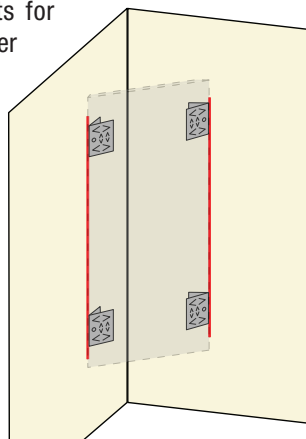

- 3 For vertical corners align the panel 3/4" above its target height and press down at a 45° angle until flush with the wall. For horizontal installations apply Tubetak Pro adhesive to the impaling clip face, not to the points.

Align the panel laterally with the top edge flush with the ceiling and just touching all four impaling points. Press the panel straight towards the wall.

Note that the panel cannot be removed without damage once the adhesive cures.

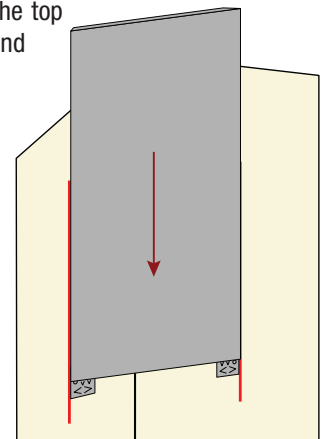

Guidelines For Outlet Cutting

NOTE: Auralex is not responsible for damage done to any ProPanel during modification.

- 1 Measure outlet locations on the front of the ProPanel. Cut two diagonal lines in a crisscross pattern from corner-to-corner of the cutout.

Step 1

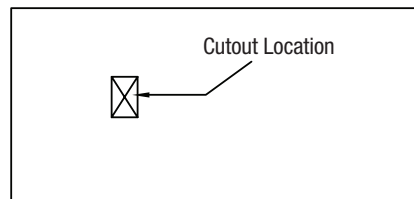

- 2 Lay back each flap of fabric and, with a sharp razor knife, cut through the core. Remove the cutout core.

Step 2

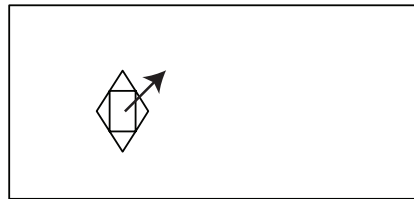

- 3 Turn the ProPanel over with the back of the ProPanel facing up. Make sure each fabric flap is exposed at the bottom of the cutout so the back of the fabric is exposed. Spray Auralex® Foamtak™ adhesive on the inside edges of the cutout and the back of the ProPanel around the cutout. Avoid getting adhesive on the face of the fabric. Let the adhesive set for at least 15 seconds. Permanent discoloring of the fabric will occur if too much adhesive is used or not enough drying time is given.

Step 3

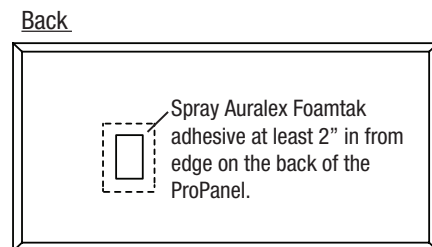
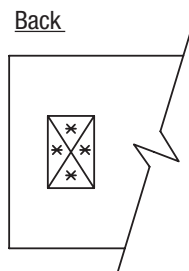

- 4 Lay each flap of fabric back in the cutout, pressing each flap against the inside edge of the cutout. Return each flap to the back of the ProPanel and press the fabric firmly to the adhesive.

- 5 The panel is now ready to install. **NOTE: A cover plate should always be placed over any cutout in a ProPanel.**

Step 5

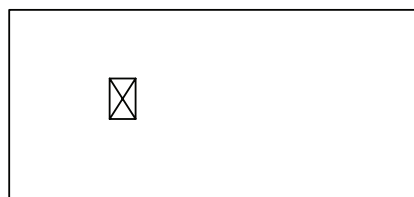

Guidelines For Edge Cutting

NOTE: Auralex is not responsible for damage done to any ProPanel during modification.

Follow these instructions to edge cut your ProPanels. The fabric is only laminated to the edges and the back of the ProPanel. No adhesive was, or should be, used on the face of the ProPanel. Therefore, when you pull the fabric from the back and edge, it will fall away from the face of the ProPanel.

- 1 Lay the ProPanel down with the fabric face up. Start from the back of the ProPanel and pull the fabric away from the back and edges of the ProPanel. Pull the fabric back at least two inches beyond the cut line. Mark the core at the desired cut line. Be sure to deduct for the fabric thickness.

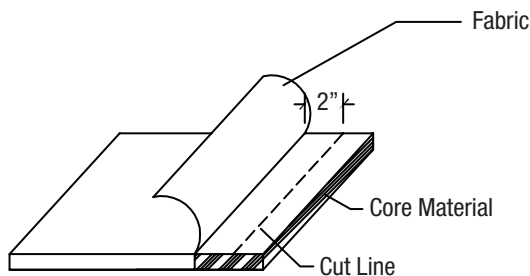

- 2 Clamp a straight edge at the cut line. Cut through the core, following the straight edge.

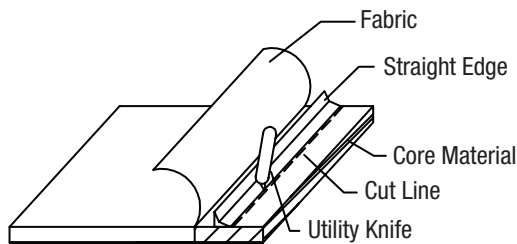

- 3 Cut the fabric, leaving two inches more fabric than the core and edge thickness.

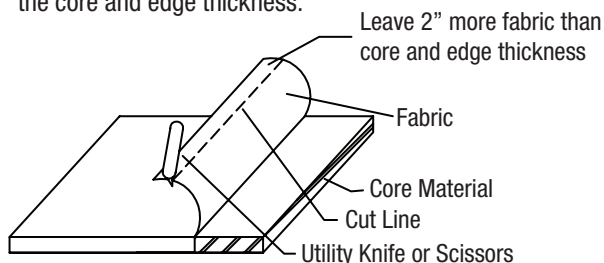

- 4 Roll the fabric so the back of the fabric is at the edge of the cut line (see drawing below). Lightly spray Auralex® Foamtak™ adhesive on the exposed edges. Do not get adhesive on the face of the ProPanel. Let the adhesive set for at least 15 seconds. Permanent discoloring of the fabric will occur if too much adhesive is used or not enough drying time is given.

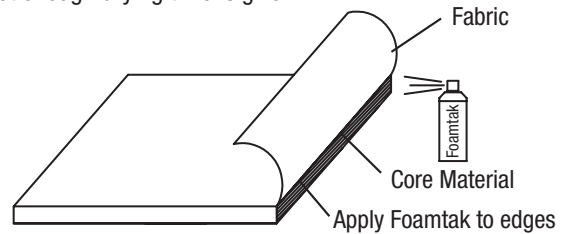

- 5 Starting at the middle of the cut edge, gently pull the fabric taut (without distorting the fabric) and press it against the edge of the ProPanel. Work toward one end. When complete, go back to the middle and, using the same techniques, work to the other end of the cut edge.

- 6 After the fabric is pressed to all edges, and after confirming that the table is clean, turn the ProPanel face down. Apply Auralex Foamtak adhesive on the back of the ProPanel 2" in from the edge and to the back of the fabric. Press the fabric down to the back of the panel along the edges and press the fabric together at the corners.

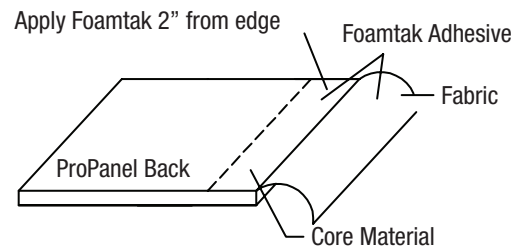

- 7 At the corners, trim the back and edges with sharp scissors. Leave enough fabric to close each corner. Install the ProPanel.

