

Acoustics 101™

Practical Guidelines For Constructing Accurate Acoustical Spaces

Including Advice On The Proper Materials To Use

by
Eric T. Smith

Edited by
Jeff D. Szymanski, PE

July 2004
Version 3.0



FOREWORD.....4

WELCOME.....4

CHAPTER 1.....6

BASICS OF ACOUSTICS.....6

ACOUSTICAL DEFINITIONS7

Acoustics 101 Definitions7

GENERAL TECHNICAL INFORMATION9

STC.....9

Absorption Coefficients and NRC12

A final thought13

CHAPTER 2.....14

MATERIALS AND PRODUCTS DISCUSSED.....14

Common Construction Materials14

Specialty Construction Materials15

Auralex Products16

CHAPTER 3.....18

FLOORS18

Stringers21

CEILINGS22

(Non-)Flat Ceilings.....23

Cathedral Ceiling Treatment for Live Rooms24

Mr. T (Bar).....25

WALLS.....26

Existing Walls26

Construction27

CHAPTER 4.....29

DOORS29

Isolation29

Garage doors30

Airlocks.....30

WINDOWS31

Exterior31

Interior31

HVAC (HEATING AND COOLING SYSTEMS)33

The Air Handler33

The Fan34

Connections34

<i>Ducts</i>	34
<i>Terminations</i>	36
ELECTRICAL ISSUES	36
CHAPTER 5	38
MONITOR MOUNTING SOLUTIONS	38
ROOM DESIGNS	38
<i>Angled Surfaces</i>	38
<i>Room Dimensions</i>	39
<i>The Acoustics 101 Room</i>	40
<i>5.1 Mixing Rooms</i>	40
<i>Other Resources</i>	41
APPLICATION EXAMPLES	41
<i>General Resources</i>	41
<i>Night Club Isolation</i>	41
<i>Garage Isolation and Treatment</i>	42
MORE CONSTRUCTION TIPS	43
PERSONALIZED ROOM ANALYSIS FORM	44
APPENDIX 1	45
LINKS	45
<i>Online Forums</i>	45
<i>Professional Organizations</i>	45
<i>Professional Design Assistance</i>	45
<i>Acoustical Prediction, Test and Measurement</i>	45
<i>Cool Corporate (non-Auralex) Stuff</i>	45
<i>Cool People</i>	46
<i>Other Cool Stuff</i>	46
APPENDIX 2	47
THE ACOUSTICS 101 ROOM	47

FOREWORD

WELCOME

Welcome to our newly expanded and revised Acoustics 101.com, the world's best source for bottom line, no BS, just-the-facts-ma'am advice on how to build a good sounding recording studio or listening room. The tips contained in this small booklet have worked for me and have worked for others, including many of our most famous clients. They will work for you and, if well implemented, should actually exceed your sonic requirements and expectations without breaking your piggy bank. These tips can save you a lot of time and grief!

What follows in Acoustics 101 is knowledge we've gained over our decades of experience in broadcasting, music and acoustics - all condensed into one handy little reference guide and put into language virtually anyone interested in controlling sound can understand. It doesn't contain any hard-to-decipher charts or graphs. There's no smoke and mirrors, no dog and pony shows. Just good, solid, cut-to-the-chase advice that you'd be hard pressed to find anywhere else — and certainly not for free! We used to sell Acoustics 101, but are happy to be in a position now to provide it here for you at no charge. As acoustical consultants, we often charge quite healthy sums to impart this sort of knowledge, but feel free to read Acoustics 101 at your leisure....there's certainly no "per diem" charge like there'd be if we came out to consult you in person!

How confused you must be when you read so many conflicting opinions in the audio press about the "right" way to control sound—or even how to form a "correct" opinion of your own about what constitutes "desirable" sound. I feel your pain. All I can say is this: we at Auralex have decades of experience in broadcast, studio design, live performance and recording and have never had a single complaint about advice we've given. As the president of Auralex, I feel confident in saying that we know what it takes to make good sound and what it takes to make a room sound good. Frankly, our famous clients attest to our level of knowledge and the quality of our acoustical products. Collectively, we've built, worked in and consulted enough facilities that we've got something quite valuable to offer you; something my personal search long ago taught me simply isn't available anywhere else. We provide GREAT acoustical advice that doesn't cost an arm and a leg and that us plain folks can understand and put into practice all by ourselves.

One thing you'll probably notice right away - Acoustics 101 is brief and to the point. No lab values, no intense charts, no graphs. No 500 pages of tiny print for you to weed through just to find the answer to some basic question... just real-world advice. So, if you're a technohead who's obsessed with formulas and who believes computers and calibrated reference mic's are absolutely necessary to build a good-sounding room, you may not find in Acoustics 101 what you're looking for. There are plenty of books at your local library written in that high-brow style; I should know, I've read most of them. If you have, too, and they got your head spinning and eyes rolling around like BBs like they did mine, you've come to the right place. Acoustics 101 will give you just the sort of real world advice you were hoping you'd find in all those other books, but without all the additional fluff and tough-to-follow equations.

If you've not read all the other books out there, great! Acoustics 101 could save you hours and hours of time and trouble because we've taken everything we've learned, thought up, observed and heard about in all our years in broadcasting, recording and pro sound and condensed the best parts down into Acoustics 101.

Are these tips the same ones you could get if you hired the "million dollar room" guys? In some cases, yes they are. Are these tips guaranteed to give you the world's best recording studio, one that'll test better than Oceanway and cost only \$100 and 2 hours time to build? Not entirely, but we do

give you tips on how to build rooms that capture the essence of the million dollar rooms. (It should be noted that we've been called in by clients quite a few times over the years to fix acoustical problems the million dollar guys either [a] caused, [b] overlooked or [c] weren't able to solve at a price the client could afford.)

What these tips will do is give you a solid basis of knowledge with which you can build a very functional recording studio, listening room or production facility without having to beg the bank for a loan. If you can follow directions, can think logically, have a little bit of money to spend and know how to do basic carpentry while paying careful attention to detail, you're well on your way to building yourself a solid, quiet room! Then, once it's built, if you treat your room with the appropriate Auralex acoustical products, you'll also have a great sounding room, one that'll be a pleasure to work in...be in...create in.

I'm no longer a commercial radio personality, but I'm still active in freelance voice work for commercials, messaging-on-hold, documentaries and more, and we're building our production companies, Captive Audience™ Inc. and Alien Multimedia, Inc., a new multi-studio digital audio and video complex at our new headquarters. Everything you'll read in Acoustics 101 is being put to use at our own new facilities, so you know I personally place a lot of trust in these solutions.

I'm fully aware that there are loads of famous acousticians out there who have written books and probably would be glad to spec out your new studio for you if you were willing to pay them \$1200 an hour or, in a few cases, no less than \$50,000...no matter how small your project. I'm also aware that many of them know no more than we do and that many of them know even less than we do. While the million dollar room guys can make acoustics seem like rocket science when it's appropriate and the budget allows (or when the client needs a dog and pony show to feel good about all the money they're spending for consulting), often you and I don't need that level of tedium and expense. We need somebody to give us good, easily-implemented advice. Acoustics 101 does just that.

Another thing you'll notice: this booklet recommends that you use some of the products sold by Auralex. Now, are you free to substitute other companies' products if you choose? Sure you are; nobody's twisting your arm. But [a] we've giving you lots of free advice that'll save you tons of time and money, so I think we deserve your support, and [b] you won't be able to find similar products that exhibit all our products' benefits and advantages at anywhere near our prices. This booklet is intended to provide you with sufficient knowledge so you can make the choice for yourself that Auralex products are simply the best available to you regardless of price. Even if you do ultimately decide to use other firms' products, though, we know you'll have a better understanding of acoustics and reap more enjoyment from sound in general having read Acoustics 101. If we can help facilitate that for you, we've done our job.

So, enjoy! We hope it answers the questions you've had floating around in your head and that you find the information it contains to be both easy-to-understand and useful. Now, get out there and build a great room, make great sound, make great money and most importantly ENJOY YOURSELF. You can do it!

By the way, USE YOUR HEAD WHEN YOU USE YOUR EARS™ — LISTEN RESPONSIBLY!

Sincerely,

A stylized, handwritten signature of Eric Smith in black ink.

Eric Smith
Founder and President ("Fearless Leader")
Auralex Acoustics Inc.

CHAPTER 1

BASICS OF ACOUSTICS

If you are reading this, you are very likely interested in improving your sound. The concepts put forth in these pages are not new. They are not revolutionary. You can find them in many other texts. Our hope is that our presentation and treatment of these topics will be “down to earth” and easier to understand, putting complex concepts into perspective.

Acoustics is not all common sense. Unfortunately, the subject can sometimes be quite confusing. However, we are confident that you can build a great room by following *Acoustics 101*. And there is nothing stopping you from taking these concepts and coming up with even better ideas than what we have presented herein. If you do, that's great! Fax or e-mail us your ideas so future *Acoustics 101* readers can benefit from what you have developed. What you are reading right now is the newest incarnation of *Acoustics 101*. Many contributions from readers like you have been incorporated into this “new and improved” version. The only thing about making changes is to make sure you have really thought through the ramifications of what you are doing. Random substitutions could degrade everything you are trying to accomplish. If you are unsure, contact us.

Some of the basics of how sound behaves are implicit in *Acoustics 101*. Some examples of concepts we assume you have a basic understanding of include:

- When sound strikes a surface, some of it is absorbed, some of it is reflected and some of it is transmitted through the surface. Dense surfaces, for the most part, will isolate sound well, but reflect sound back into the room. Porous surfaces, for the most part, will absorb sound well, but will not isolate.
- The best way to stop sound transmission through a building structure is to isolate the sound source from the structure before the structure has a chance to vibrate.
- Walls need to be isolated from ceilings and floors, usually by means of dense, pliable rubber.
- The main ways to minimize *sound transmission* from one space to another are adding *mass* and *decoupling*.
- *Limp mass* is most often better than *rigid mass* (actually, a combination of the two is really what you are after).
- Every object, every construction material has a *resonant frequency* at which it is virtually an open window to sound — kind of like a tuning fork that “sings” at its particular resonant frequency.
- Different materials have different resonant frequencies.
- Trapped air (a.k.a., air spaces and air gaps) is a very good decoupler.
- Airtight construction is a key concept. Sound, like air and water, will get through any small gap. (Sound can leak through openings as small as 1/32” – in some cases even smaller.)
- Sound bounces back and forth between hard, parallel surfaces.

One of the single biggest concepts to understand and appreciate is that acoustic foam, one of our core products, is not going to “soundproof” your room. It is an extremely effective absorber of ambient, reflected sound and helps make rooms “sound better.” Acoustic foam does contribute *some* sound isolating properties (mostly high frequencies), but is not sufficient by itself to keep sound in or out of a room. Thicker acoustic foam is better at absorbing low frequency sounds. Controlling

reflected sound within a room is extremely important in producing good sounding recordings. When you hear Mike Wallace's voiceovers on 60 Minutes, you might be surprised to find out that they did not spend a million bucks on it. (It is amazing what some good 2" acoustic foam can do for a glorified, yet well-constructed closet!)

Isolation construction – the core concept in *Acoustics 101* – is not inexpensive. *Acoustics 101* carries with it an assumption that you have a few bucks to spend to make your studio the best it can be. For example, it is important to realize that empty egg cartons, cork squares and carpet scraps are not going to (a) keep sound from leaving or intruding upon your studio and (b) yield that pleasing, neutral, "Mike Wallace" sound within your studio.

If the guidelines, tips, techniques and advice in *Acoustics 101* are improperly implemented, the desired results will *not* be achieved. *Auralex* cannot be held liable for the advice given because we are not going to be there watching you do the work or assisting with the construction. Please note that these tips are being provided on this website free of charge.

If you cannot handle a circular saw and other common power tools or you do not have the money to hire someone who does, then you should probably stop right here. It is going to be difficult to implement the advice given here if you or someone you hire cannot handle basic construction methods, such as applying drywall tape and mud, creating solid, airtight and level partitions and floors, "measuring twice; cutting once," etc.

There are myriad benefits to constructing your control room to be symmetrical geometrically and building using the best materials you can afford. Money well spent now will benefit you for a long time into the future.

One of the keys to getting good, clean sound on tape or hard disk is removing the sound of the room from the equation, to one degree or another. For a great example of this objective successfully implemented, listen to the Eagles' *Hotel California* or Pink Floyd's *Dark Side Of The Moon*.

Some of you will be able to grasp all this quicker than others. Please understand that any extra effort you expend implementing the tips contained in *Acoustics 101* will pay you back sonically for a long time to come. Make no mistake: they are worth whatever work it takes to put them into practice.

ACOUSTICAL DEFINITIONS

For a complete treatment of acoustical terms defined, two additional sources are recommended (besides the overview of the most important terms discussed in *Acoustics 101*):

[Rane's Pro Audio Reference](#) (free web-based dictionary of audio and acoustical terms)

and

[ANSI Standard S1.1-1994](#) (\$150.00 – official, standardized acoustical definitions)

Acoustics 101 Definitions

Noise Reduction Coefficient (NRC)

NRC is a single-number rating representing an overview of how much sound is absorbed by a material. Example: ½" gypsum board ("drywall") on 2x4 studs has an NRC of 0.05.

Soft materials like acoustic foam, fiberglass, fabric, carpeting, etc. will have high NRCs; harder materials like brick, tile and drywall will have lower NRCs. A material's NRC is an average of its absorption coefficients at 250, 500, 1000 and 2000 Hz. In general, the higher the number, the better the absorption. NRC is useful for a general comparison of

materials. However, for materials with very similar NRCs, it is more important to compare absorption coefficients.

Absorption Coefficient (α)

The actual absorption coefficients of a material are frequency dependent and represent how well sound is absorbed in a particular octave or one-third octave band. Example: ½” drywall on 2x4 studs has an absorption coefficient at 125 Hz of 0.29.

Comparing the absorption of materials should involve a comparison of their respective absorption coefficients in the different bands. Provided the materials are tested in a similar fashion, the material with a higher absorption coefficient in a particular band will absorb more sound in that band when you use it in your room. Be careful though: Materials are tested using different *mounting methods*. For example, if one material is tested by laying the materials out on a predetermined area of the floor – called *A mounting* – and another tests their materials by spacing them off the floor by several inches, then the comparisons are “apples and oranges.” To truly compare, find numbers derived from tests that used the same layout of materials in the test chamber. Also, there are three main standard methods used to test materials for absorption. Two of them are *reverberation chamber* methods – *ASTM C423* in the U.S.A. and *ISO 354* in Europe. These two methods are quite similar, but the *ISO* method – in general – will produce slightly lower overall numbers than the *ASTM* method. The other method is the *impedance tube* method, or *ASTM C384*. This method places a small sample of the material under test at the end of a tube and measures the absorption. Again, the numbers from this test are usually lower since a different method of calculation is used. They are also not as representative of real-world applications of materials relative to the reverberation chamber methods.

Sound Transmission Class (STC)

STC is a single-number rating of how effective a material or partition is at isolating sound. Example: ½” drywall has an STC of 28.

Hard materials like rubberized sound barriers, concrete, brick and drywall will have high STCs. Softer materials like mineral fiber, acoustic foam and carpet will have much lower STCs. Virtually every material filters out some of the sound that travels through it, but dense materials are much better at this than are porous or fibrous materials. Like NRC, STC is useful to get an overview-type comparison of one material or partition to another. However, to truly compare performance, the *transmission loss* numbers should be reviewed.

Sound Transmission Loss (STL or TL)

STL represents the amount of sound, in *decibels* (dB), that is isolated by a material or partition in a particular octave or one-third octave frequency band. Example: ½” drywall has an STL at 125 Hz of 15 dB.

Comparing material or partition performances should involve comparing the STLs of each in the different bands. If both materials or partitions are measured in accordance with the STL/STC standard, ASTM E90, then the comparisons being made will be “apples to apples.” It should be noted that real-world performance is not going to provide the same level of STL that is achievable in the laboratory. However, the relative performance of one material or partition versus another typically holds true in real-world

construction. I.e., if the lab measures one partition better than another, it should hold true for a real partition built in your studio. Even though an actual field test of a concrete wall might reveal a *field STC* (FSTC) that is 5 points lower than the lab test, it is still better – relatively speaking – than a simple, single-leaf, uninsulated drywall partition in the same configuration.

Decoupling

This is the concept of detaching partitions from each other, or physically detaching layers in a partition in order to improve sound isolation.

The most common methods of decoupling are:

- Air gaps or air spaces between two partitions.
- Using resilient channels (RC8 from *Auralex*) between layers and structural framing members for walls and ceilings.
- “Floating” a floor using springs, rubber isolators (such as *U-Boats* from *Auralex*), or other decoupling layers.

Room Modes

A room mode is a low frequency standing wave in a room.

Normally, this is a small room phenomenon, though large rooms have (very, very low) modes as well. A mode is basically a “bump” or “dip” in a room’s frequency response that is facilitated by the room’s dimensions and the way those dimensions cause sound waves to interact with each other. There are three types of room modes

- *Axial* modes: Standing waves between two parallel surfaces.
- *Tangential* modes: Standing waves between four surfaces.
(Click [here](#) for illustrations and further discussion of axial and tangential modes.)
- *Oblique* modes: Standing waves between six surfaces. (Oblique modes are more complex, higher in frequency and decay faster. Therefore, they are not typically a big problem.)

For a complete treatment of modes, there are ample discussions in [acoustic reference books](#). There are intricate formulas in these texts that can help you determine your room’s modes. There is also software that can do the same. We have developed our own proprietary software and would be glad to work with you or your salesperson in figuring your room’s modes to help steer you in the direction of the proper acoustical treatments. (Note that rectangular rooms are the easiest to predict. Our software is based on rectangular rooms. For non-rectangular spaces, we can assist to a degree, but the software required to actually predict the exact modes – which *Auralex* does not use – is much more complex.)

GENERAL TECHNICAL INFORMATION

STC

As mentioned before, *mass* and *decoupling* are the two components that are most effective at stopping the transmission of sound from one space to a neighboring space. This fact is plain to see when you examine the Sound Transmission Classes (STCs) of various types of walls. The following illustrations of wall constructions represent a small sampling of the myriad possibilities:

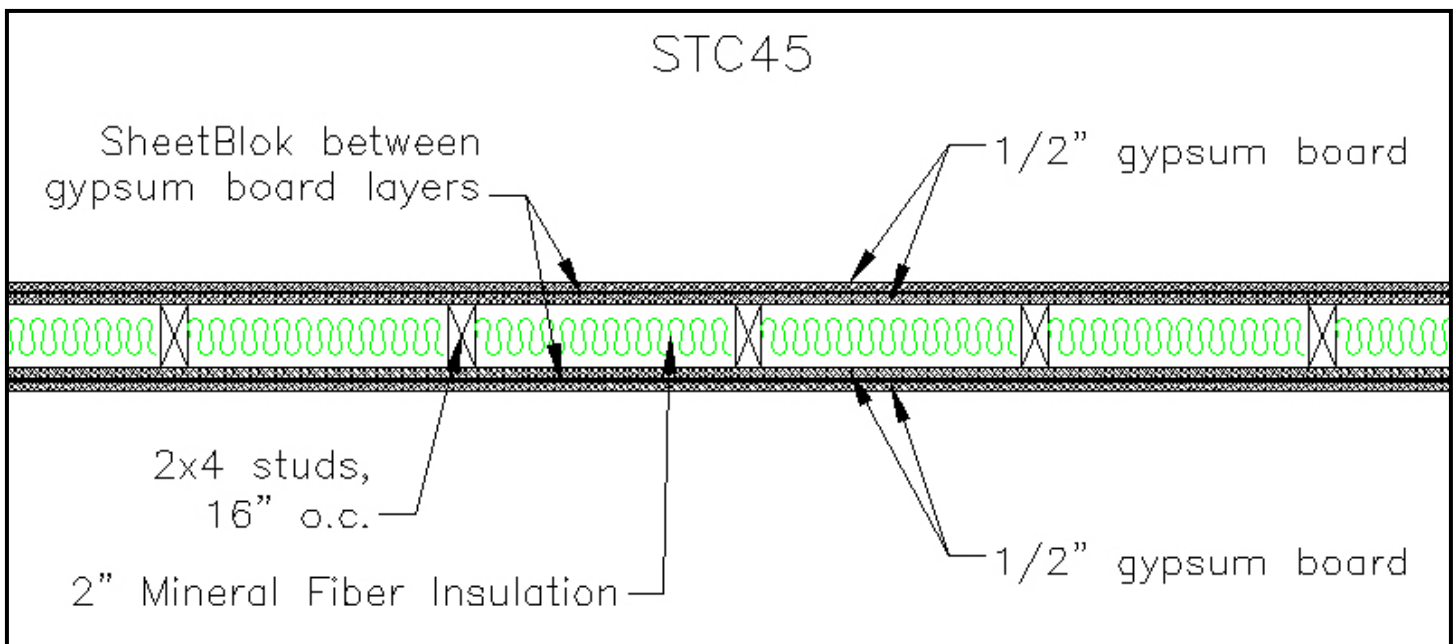
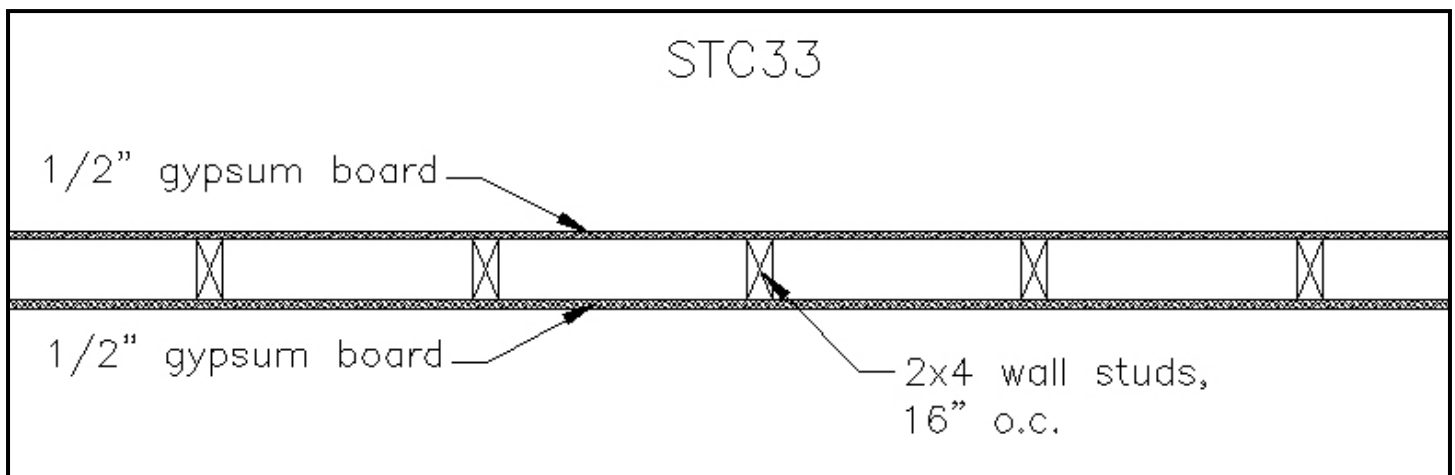
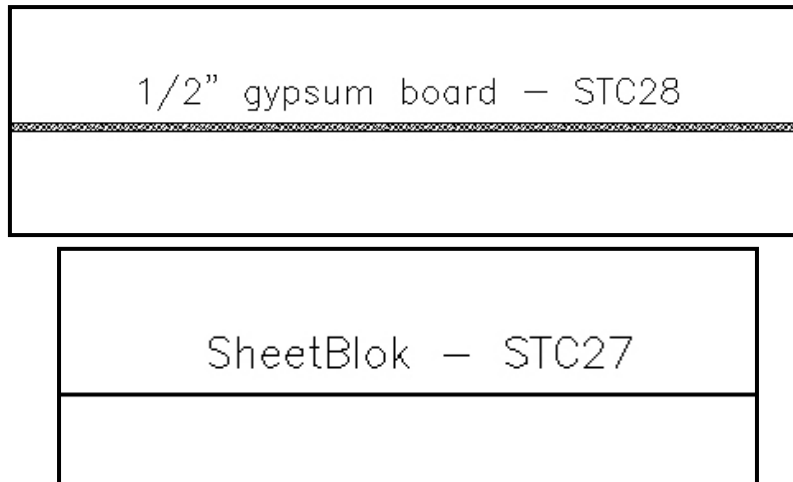

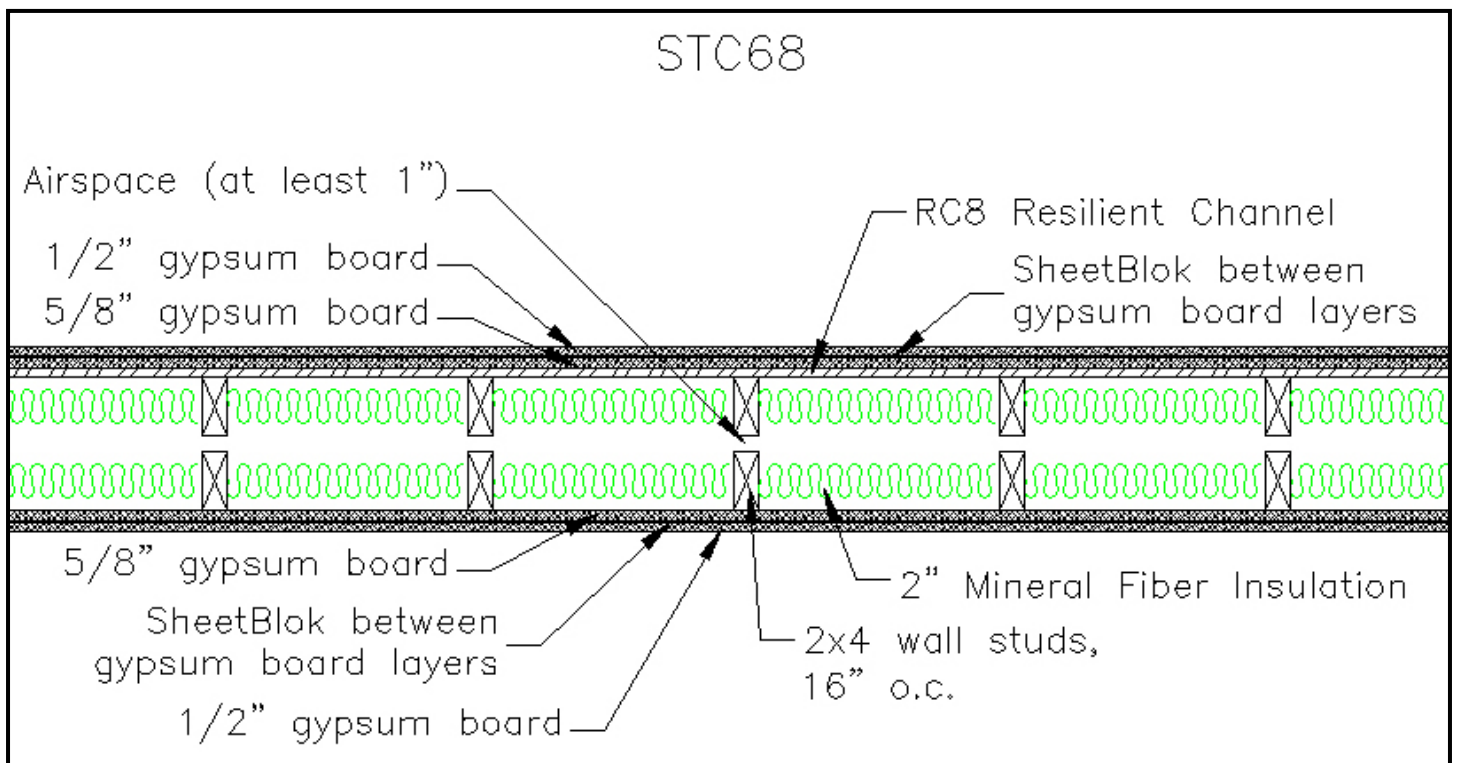
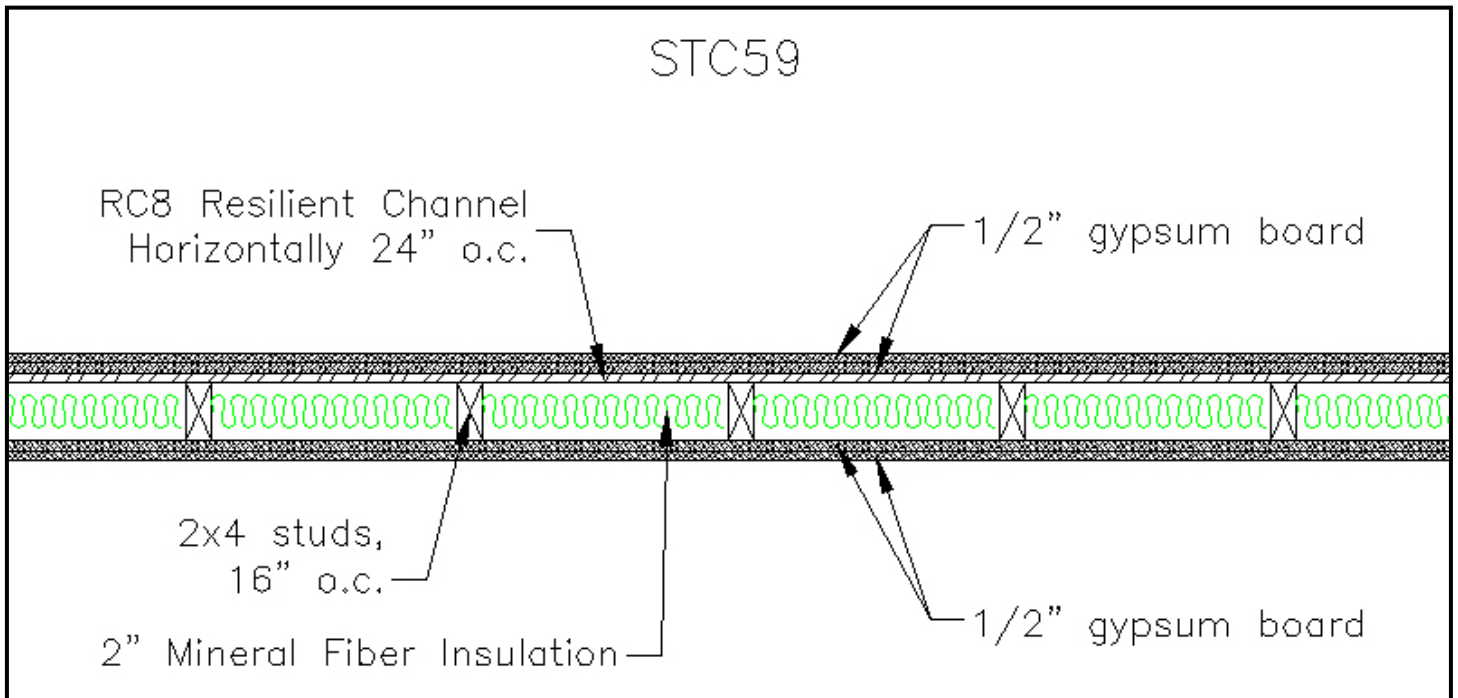

Note: "Gypsum board" is a generic name. Brand names include "Drywall™" and "SheetRock™." Also, metal studs (instead of wood) will provide incrementally higher STC for each of the configurations above.

The following table gives a subjective equivalent for different STCs:

Subjectivity of STC		
STC	Conditions	Subjective Rating
< 30	Normal speech heard and understood	Poor
30-35	Loud speech heard and understood; normal speech heard but not understood	Fair
35-40	Loud speech heard but not understood; normal speech faint	Good
40-45	Loud speech faint; normal speech inaudible	Very good - minimum required for studios
> 45	Loud sounds faint	Excellent - design goal for most professional studios

And finally, we would encourage the reader to review the [STC FAQ](#) for a more complete discussion.

Absorption Coefficients and NRC

The table below shows absorption coefficients and Noise Reduction Coefficients (NRCs) for some common building materials. They plainly illustrate the need for specialized acoustic treatments in studios that require well-controlled sound.

Material	Center Frequency of Absorption						NRC
	125	250	500	1000	2000	4000	
½" gypsum board on studs (16" o.c.)	0.29	0.10	0.05	0.04	0.07	0.09	0.05
Painted concrete block	0.10	0.05	0.06	0.07	0.09	0.08	0.05
Window glass	0.35	0.25	0.18	0.12	0.07	0.04	0.15

Some other useful links include:

- The [Auralex Master Acoustical Data Table](#) (PDF)
- The [NRC FAQ](#) for a more detailed discussion.

A point that is worth reiterating here is the fact that absorption coefficients and NRCs are not percentages. In other words, if a material has an NRC of 1.10, it simply means that more sound (on average) is absorbed than a material with, say, an NRC of 0.50. A few more facts about NRC that you may want to know when comparing acoustical materials:

NRCs can only be multiples of 0.05. For example, and a material that is reported to have an NRC of 0.72 was probably not tested in accordance with the standards.

Absorption coefficients and NRCs can only be reported for materials tested in accordance with very specific mounting methods. Beware of absorption coefficients and NRCs that were "calculated" using numbers that were only reported by the testing lab as "Sabins per unit." (One of our competitors is

notorious for this.) Since there was not standard area under test, converting to absorption coefficients and NRCs is forbidden per the ASTM standards.

A final thought

STCs and NRCs are both very useful numbers for comparisons. However, if two (or more) materials or constructions are being compared and their STCs or NRCs are very close, the octave band or 1/3-octave band data should be compared. This is discussed more thoroughly in the FAQs mentioned above. Should you be unsure of how to make certain comparisons, please [contact us](#) and we'll be happy to assist!

CHAPTER 2

MATERIALS AND PRODUCTS DISCUSSED

In *Acoustics 101* a few general materials, as well as specific *Auralex* products are discussed. You may or may not be familiar with all of them, so we will cover them here in detail to get that out of the way! Your local lumberyard or hardware store can probably guide you if you do not know exactly where to pick up the items discussed, just be careful not to let them steer you wrong with substitutions or deletions. What worked *once* to construct a tight, good-sounding recording studio will always work because sound never changes. *Auralex* has no interest in reinventing the wheel, which is exactly what we would be doing if we attempted to make claims that were counter to the proven construction techniques that are “out there.” The methods and materials outlined here have proven themselves to work many times over and should prove more than sufficient for your needs.

Also, with few exceptions, do not add multiple layers of the materials specified; in this case more is not necessarily better due to diminishing returns. (For reasons we will cover, going from two layers of gypsum board to four is a good thing. Going from four layers to six or eight, however, might not be worth the added cost/trouble.)

You can construct a perfectly good-sounding, airtight recording studio with common, easily-located materials. There is simply no “magic” material that you absolutely must use if you are to have a good room. The materials discussed herein are available at any decent lumberyard and will not set you back two years’ salary.

Common Construction Materials

- *Wood and metal studs and joists* – construction framing members with which most of you are familiar. The most common framing for walls is either 2x4 wood studs or 3.5” metal studs. Which is more cost effective – metal or wood – will largely depend on the relative price of wood and steel in different parts of the country. For acoustical purposes, metal does offer resiliency benefits worth considering for maximum benefit. For those of you that are not used to building things, bear in mind when figuring your dimensions that lumber is not really the actual dimensions indicated by the name. For instance, a 2x4 is not; it is actually 1½"x3½". A 2x6 is 1½"x5½", etc.
- *Gypsum wallboard* (“GWB,” “drywall,” “SheetRock”) is commonly available in ½” and ⅝” thicknesses. It is far and away the most common building material in North America for interior finish construction. Unless you have a home built prior to the 1950s, you probably have gypsum board finish to your walls and ceilings. (Plaster on lathe was much more common – and incidentally much better for sound isolation than gypsum board – in homes prior to the construction boom of the 1950s.) Of particular interest to acoustics and construction with gypsum board is the [Gypsum Board Construction Handbook](#), published by the [United States Gypsum Company](#).
- *Plywood* is usually ¾” (but is available in a variety of thicknesses from larger lumber yards) and is either available with flat edges, or with tongue and groove edges for tight floor construction.
- The *Particleboard* family:
 - *Low density fiberboard*, or *LDF*, is typically called chipboard. It’s the stuff out of which most inexpensive, DIY furniture is made.

- *Medium density fiberboard*, or *MDF*, is more typical of shelving and loudspeaker enclosures. It has some very good acoustical properties and we like using it for many varied applications.
 - *High density fiberboard*, or *HDF*, is also available, but is quite rare and quite heavy. Very high-end cabinetry will often employ *HDF*.
 - *Oriented strand board*, or *OSB*, is often used in residential construction as a low-cost floor underlayment.
 - Straight up *particleboard* is usually a version of *LDF*, but can also be the name given to a higher grade of *OSB*.
- Other materials we make mention of in *Acoustics 101* include gypsum board screws of various thread sizes and lengths, construction adhesives including vinyl flooring adhesive, silicone caulk, etc. Wherever possible, we have provided make, model and cost information as appropriate for any non-*Auralex* materials we mention.

Specialty Construction Materials

- *Soundboard* is often misunderstood, so I will try to set the record straight here. Many people mistakenly use the term to describe materials like regular *gypsum board* or even *particleboard*. This is not accurate. *Soundboard* is actually a trademarked name for a brown, compressed paper board that is usually ½" or ⅝" thick and is manufactured by the [Celotex Company](#). The best way to describe it for you here is to say that it is a lot like a sheet of Masonite or pegboard, only thicker and a bit softer. A similar material is [Homasote](#). If you describe *Soundboard* or *Homasote* to your building materials supplier, he or she can probably direct you to it. It is pretty dense, so it makes a good layer in a multi-layered wall configuration. In conjunction with layers of ⅝" gypsum board, ¾" *particleboard* or *MDF* and *SheetBlok*, it is really effective at blocking the transmission of sound. (It should be noted that when compared side by side with *gypsum board*, *Soundboard* is not quite as good in a straight up STC comparison. Click here for an illustration. It is not clear what sort of performance *Homasote* offers versus *gypsum board* or *Soundboard*. Bearing that in mind, *Soundboard* is good if you want to change up the composition of the layers in your construction. This will dissipate resonances well. However, for sheer mass, *gypsum board* is a much more cost-effective alternative.)
- *Blueboard* is also a very misunderstood material. This is typically an expanded polystyrene board that's been dyed blue, though there are also pink versions available. It's all the same – mostly useless in terms of acoustical isolation. The density of the material is very low and the material itself is a closed-cell foam. Thus, there is no mass benefit to be gained for isolation and no absorptive benefit to be gained when using it in wall cavities. Unless there is a specific code requirement for this type of material in your construction, we would encourage the use of *glass fiber* or *mineral fiber* insulation products in lieu of *blueboard*.
- *Glass fiber insulation* comes in many varieties. The most common is the pink insulation found in many attics, walls and basements. Here's a breakdown of the types of insulation, their densities and their acoustical benefits:
 - *R-11* (2" thick) through *R-30* (6" thick) "batt" insulation is very common. It has a density somewhere between 0.7 and 1.0 pounds per cubic foot (pcf) and usually comes in rolls. It is very effective at minimizing cavity resonances (resonances that occur in the air

spaces between framing members). It is the minimum insulation that should be used in the walls, ceiling and floor of any studio construction.

- Board insulation is available from the various companies that specialize in the manufacture of insulation materials. It is typically yellow in color and 2'x4' or 4'x8' in size with thicknesses varying between ½" and 4". You may hear it referenced using Owens-Corning's "700 series" designations, e.g., "703" and "705." It is more effective than "batt" insulation at combating cavity resonances. It also has a mass advantage since it is offered in densities from 2.0 to 8.0 (or more) pcf.
- Either of the above can be purchased with kraft paper or "FRK" (foil-reinforced kraft paper) facings on one or both sides. Two advantages the facings offer are (a) ease of handling and (b) decreased high frequency absorption. The latter is achieved only if the material is not physically inside the wall, ceiling or floor. Thus, if you have the option of buying faced insulation, we would encourage it from the simple standpoint of not having to deal with as much of the irritation associated with handling glass fiber materials.
- *Ductboard* is a variation of glass fiber insulation, typically 3 pcf and available in ½", 1" or 2" thicknesses. There is usually and FRK backing on one side and a black scrim facing on the other. Used inside ducts, this type of material can help minimize turbulent airflow noise in HVAC systems. Since the black scrim facing contains the fibers, it can also be used as a low-cost wall absorber. It should be noted that the ½" thick material is rare. The 1" thick material is very common and is the minimum that should be considered for any acoustical application.

Auralex Products

- [Studio-grade Mineral Fiber Insulation](#) is a special, denser type of insulation that the top studio designers are known to use to improve a room's level of soundproofing. Its greatly increased density when compared to the traditional, pink, glass fiber insulation makes it more effective at stopping the transmission of sound from one room to another. Plus, our *Mineral Fiber* features a much higher burning point than standard fiberglass insulation and has a radically lower rate of moisture absorption. Our *Studio-grade Mineral Fiber* is available in 1", 2", 3" and 4" thicknesses in 2'x4' sheets.
- [SheetBlok™ Professional Sound Barrier](#) is our proprietary, limp mass, dense, vinyl sound barrier material available in 10'x4' sections or 30'x4' rolls. It weighs one pound per square foot (1 lb/ft²) and is about ⅛" thick. It is flame retardant, easy to install with plastic-cap nails, staples or trowel-applied multi-purpose vinyl flooring adhesive. We also offer [SheetBlok-Plus](#) which is the same as *SheetBlok*, except with a very strong peel-and-stick adhesive backing that makes installation a breeze. *SheetBlok* is safe, inexpensive, easy to work with, more effective, easy to cut with scissors or an ordinary utility knife and is FedEx shippable right to your door. *SheetBlok* is quite simply one of the best investments in good sound control that you will ever make. Other *SheetBlok* links:
 - [Installing SheetBlok](#)
 - [SheetBlok MSDS \(PDF\)](#)
 - [SheetBlok Technical Data Sheet \(PDF\)](#)
- [U-Boats™](#) physically decouple ("float") a floor without having to use rigid mechanical fasteners like screws (and without having to take out a second mortgage!). *U-Boats* make quick work of floating a floor at a price virtually anyone can afford. They are more cost-effective than the

"pucks" that have been used in the past. Famous studios and recording artists are using them and loving them. Many multi-million-dollar studios and home-theaters-of-the-stars are floating on *U-Boats* and you have heard them at work on numerous chart-topping records. Other *U-Boat* links:

- [Spacing U-Boats](#)
- [U-Boats and weight of floor](#)
- [RC8 Resilient Channel](#) is a piece of specially shaped metal to which gypsum board or other building materials can be mounted to isolate them from the framing members (studs) of a wall or ceiling. One leg of the *Resilient Channel* attaches to the stud, the other leg to the layer of building material being hung. This isolation helps improve the structure's ability to achieve greater sound transmission loss. We sell *RC8* in bundles of 24 that are FedEx shippable and are available through your favorite dealer. Other *RC8* links:
 - [RC8 FAQ](#)

Other products discussed:

- [Tubetak™ Adhesive](#)
- [Foamtak™ Spray Adhesive](#)
- [Studiofoam®](#)
- *StopGap Acoustical Sealant*

CHAPTER 3
FLOORS

Figures 3.1a-b show good designs for those of you who have the vertical space to spare and need to float your floor (and your walls). These are perfect when a studio and control room are both going to rest on a common floor, either wooden or a concrete slab. If yours is concrete, consider (carefully) cutting a gap in the concrete between the two rooms first, then proceeding as shown. Cutting the slab is no minor undertaking, but you will be relieved to know that if you decide to do it, the gap does not need to be any wider than the width of the saw blade. N.B.: The cut must bisect the entire slab. If you are unfamiliar with the structural ramifications of doing this, please consult a local expert. Auralex cannot be held responsible if your building caves in.

Figures 3.1a-b show 2x6 joists and 2x4 walls, but if you

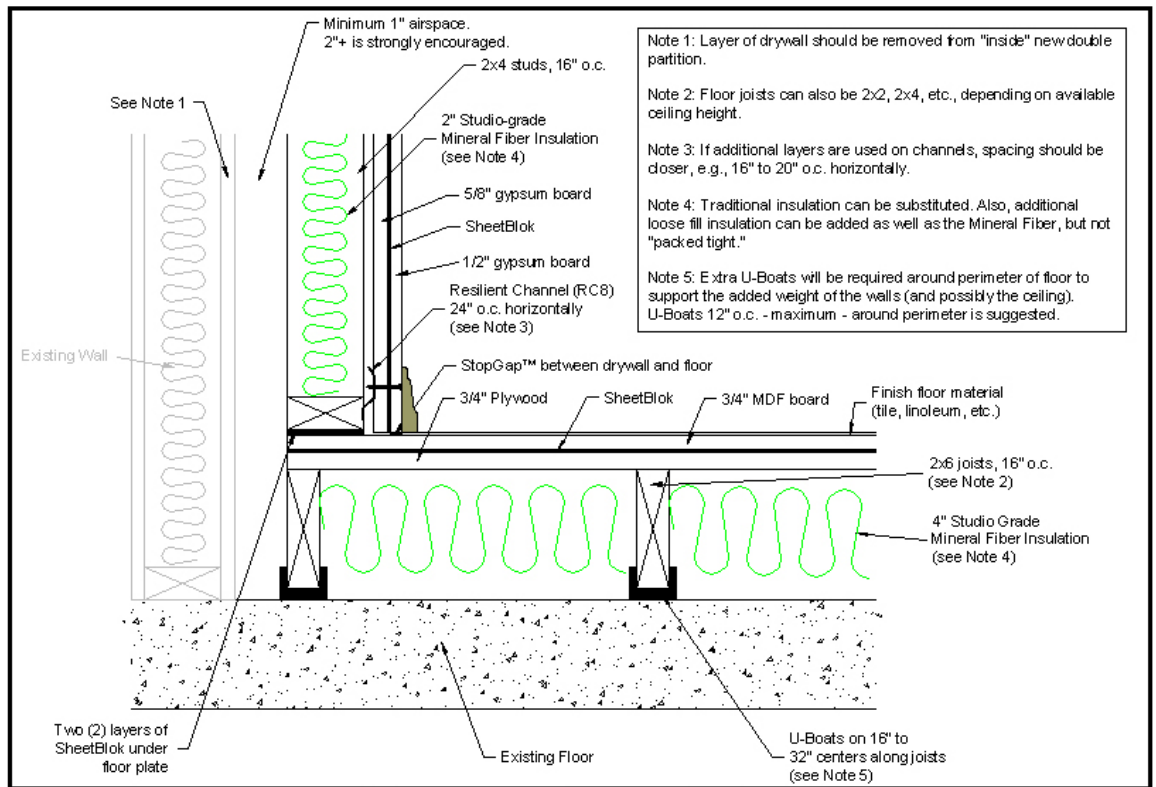

Figure 3.1a - Wall/floor construction with wall resting on floated floor.

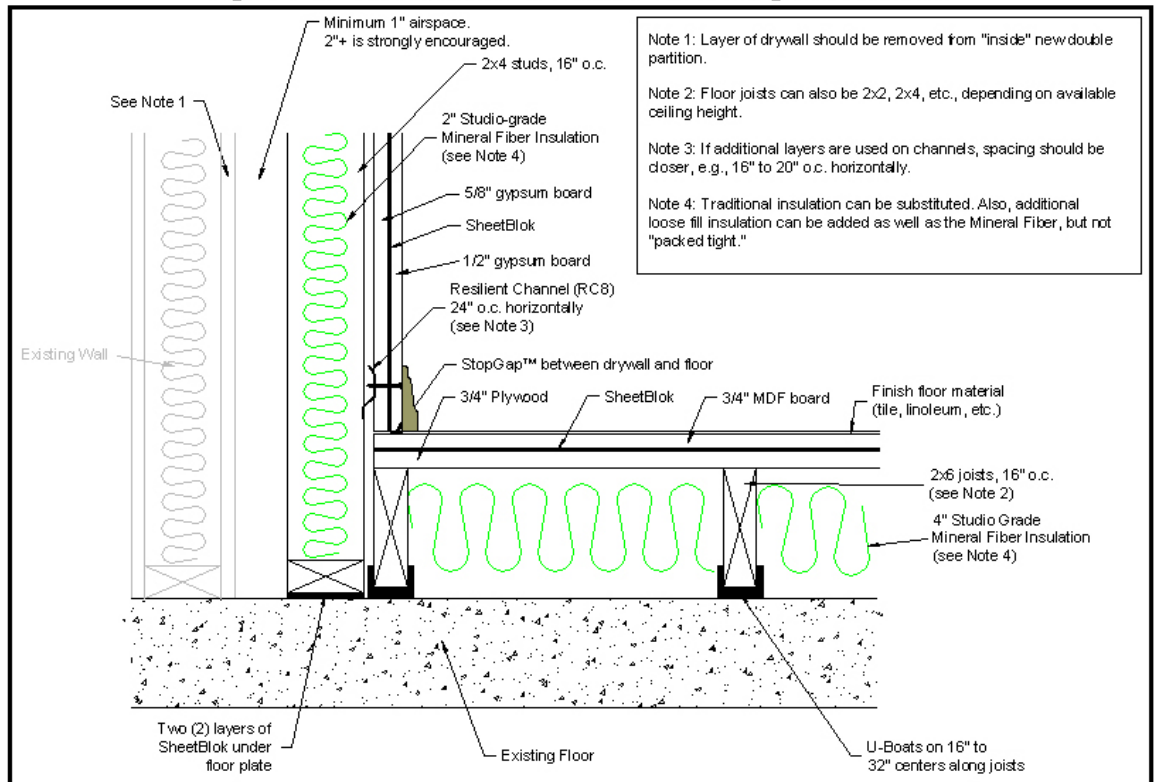

Figure 3.1b - Wall/floor construction with wall resting on existing floor.

do not have the space you can use 2x4s, 2x3s or even 2x2s for the floor. The specific material used may not matter as much as the proper implementation of the materials. I.e., the general method stays the same. The preference if you have the space is 2x6 or larger because they allow for more trapped air space and better overall decoupling. It is advisable to caulk all edges, seams and corners (as well as any penetrations – more on that elsewhere) particularly where different materials meet. Leave about a ¼” gap in parallel seams and perpendicular corners and use our new acoustical sealant, [StopGap™](#). (*StopGap* is an approved substitute for gypsum board “mud.” Tape and finish as you normally would.)

If for whatever reason you cannot build your wall/floor exactly as pictured, be it a space limitation, lack of funds, etc., first try to grasp the concepts used in the construction pictured. If you are serious about wanting to stop sound transmission, it is imperative that you isolate the sources of sound from the structure. Air and mass are your friends. Give strong consideration to making a layer of [SheetBlok](#) part of your floor sandwich.

The sill plate (bottom framing member of the wall) actually rests on two layers of *SheetBlok* to decouple it from the existing or floated floor. In a perfect world it would be preferable to glue the *SheetBlok* to the bottoms of the wall plates and joists instead of nailing it; in fact, wherever possible throughout the framing, glue any materials you can together rather than nailing or screwing them. The reason gluing is always recommended is that the adhesive itself will contribute some degree of sound isolation, too. Nails or screws serve as bridges acoustically and transmit sound from one layer to the other too well, so you want to avoid them whenever possible. Pick screws over nails (preferably used in conjunction with glue) because they form a tighter bond that yields fewer resonances. Example: We suggest gluing the particle board down and caulking the seams and boundaries. Repeat for each layer, gluing one atop the next. This makes fewer penetrations than if you screwed down each layer.

If you must screw the layers (this is very often the practical reality), be aware that it is not “the end of the world.” Just be sure to go with the absolute least number of screws possible. We recently completed a build-out on a new facility. You should be aware that most “drywallers” will simply use as many screws as they think is necessary. Even as often as every 4”! This is far too many for acoustical purposes. So keep an eye on any hired help and let them know that as few screws as they can get away with is preferred.

Same goes for when you are anchoring the walls to an existing floor (*Figure 3.1b*). If you must bolt, screw or otherwise secure the sill plate, use the least number of connection points that you can get away with. And if you are anchoring to concrete slab, look into spending a little extra on isolated bolt mechanisms. These devices provide rubber grommets for the solid bolt to go through so it does not come into direct contact with your sill plate, thereby maintaining the level of decoupling you need!

When layering, subsequent sheets of material should be rotated 90 degrees so no seams line up (see *Figure 3.2*; this staggering applies to wall, ceiling and floor materials) and, if used, the preferred “tongue and groove” (T&G) materials should be glued together at each T&G joint. As mentioned previously, all seams – regardless of material used – must be sealed up tight with something like *StopGap*.

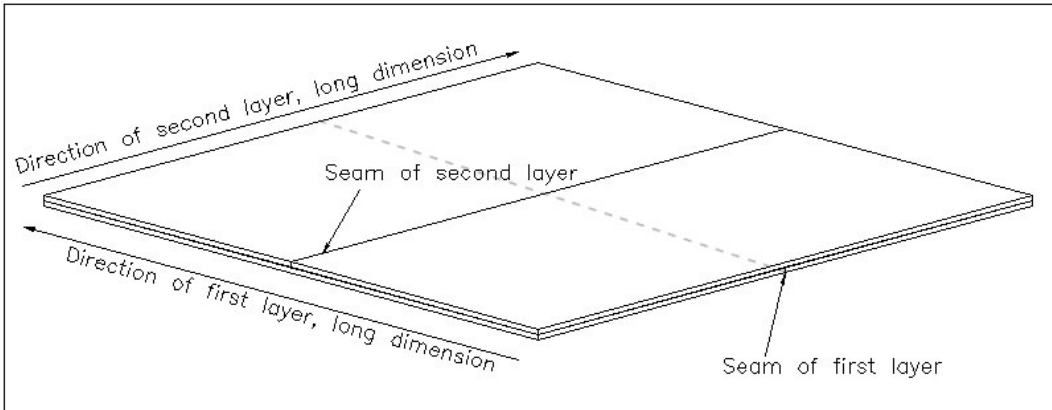

Figure 3.2 – Method for overlapping seams in multiple layer construction

Where applying baseboard or other trim you can line the bottom of it with foam weatherstrip tape to help decouple it from the floor if you are installing flat flooring like vinyl or parquet instead of carpeting. Naturally, if you are installing carpet, your carpet pad should be the thickest and

densest you can afford and accommodate from a space standpoint; 8#, 1/2" re-bond carpet pad has worked well for us under certain types of carpet like plush or Berber, while 1/4" *ComfortWear-200* (made by *GFI* and sold under a variety of trade names; it is usually purple or blue and has a honeycomb pattern embossed on one side) works well under short-pile commercial-type carpet.

Where your raised floor meets the existing walls, it is better to build it in such a way that the two have a slight physical separation (note the airspace in *Figure 3.1b*), but if you must attach them, run *StopGap* at the juncture first before attaching the final wall layer.

Do you have pretty good isolation except for when, say, someone plays piano or acoustic drums? Instead of constructing an entirely new floor, you can fashion an effective riser using [Platfoam™](#) to put on the floor under the offending instrument. A prefabricated riser is also available, the [HoverDeck™](#). This also applies to those of you in basements who do not want to frame new floors as earlier described. Kenny Aronoff and many other famous *Auralex* users are using our *PlatFoam* and *HoverDeck*. The amount of extra sound isolation you gain, as well as the dramatic improvement in the purity of the instrument that rests on the riser, make either of them an all-around winner! Kenny Aronoff is so impressed with his riser that he now has them in all the major recording markets with his identical drum kits so no matter where he is playing, he can be on an *Auralex* riser. How's that for an endorsement?????

Auralex also offers a small, portable riser called the [GRAMMA™](#) (patent-pending). *GRAMMA* stands for **G**ig and **R**ecording **A**mp and **M**onitor **M**odulation **A**ttenuator, and it is designed to float guitar cabinets, bass rigs, subwoofers, studio monitors, stage monitors and more for greatly improved isolation and purity of tone. *Tower of Power*, Lee Roy Parnell and many other famous recording artists are using *GRAMMAS* on-stage and in the studio and **LOVING** them! If you are unable to construct your room to be as sound-isolated as you would like due to budgetary constraints, physical constraints, etc., perhaps you can improve your sound **AND** your isolation by strategically implementing *GRAMMAS* under some of your amps, monitors, etc. You will be quite happy and quite surprised at the improvements!

In situations where you simply have no vertical room to spare or cannot install a floated floor, you should consider floating a couple new layers of alternated T&G flooring on two layers of *SheetBlok*. This yields increased STL and decoupling, but obviously does not give you the benefit of any trapped air space.

Stringers

There is quite a bit of debate about whether adding “stringers” to your wall, ceiling and floor construction is worth the effort. We believe it is a *great* benefit to run stringers at uneven intervals between wall studs and floor and ceiling joists before insulating them, as shown in Figure 3.7. This helps tie the whole wall, ceiling, or floor together so it is less likely to move and transmit sound. As Philip Newell has pointed out in many of his books, a stiffer construction will make it less able to vibrate at lower frequencies. Our research is ongoing and we certainly acknowledge that stringers may not be completely applicable to each and every construction. However, in the context of *Acoustics 101*, we believe it is a necessity. I.e., since the budget for construction is usually tight, we believe stringers to be a very cost-effective way to help maximize isolation.

Figure 3.7 shows stringers mounted between studs or joists. Stringers are short (14½" normally if your studs/joists are 16" on center) pieces of the same material as your joists that run perpendicular to the joists and are nailed and glued between them in a random, staggered fashion. It might seem like a pain putting them in, but it’s time well spent. We know because we have done it. We let people talk us out of them once and lived to regret it!

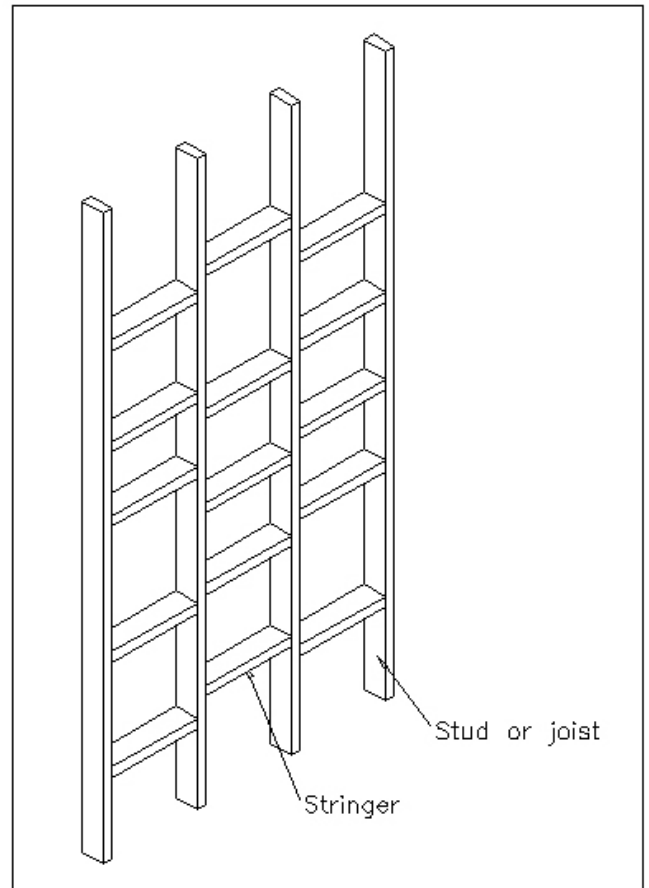

Figure 3.7 – Random placement of “stringers”

CEILING

The method for controlling structureborne sound that is passing through ceilings is much the same – see *Figure 3.3a*. Generally, we suggest layering *SheetBlok* and gypsum board either over the existing ceiling, preferably hung on [RC8 Resilient Channel](#), or as part of a lower, separated ceiling resting atop the new walls. If you are lucky enough to have vertical

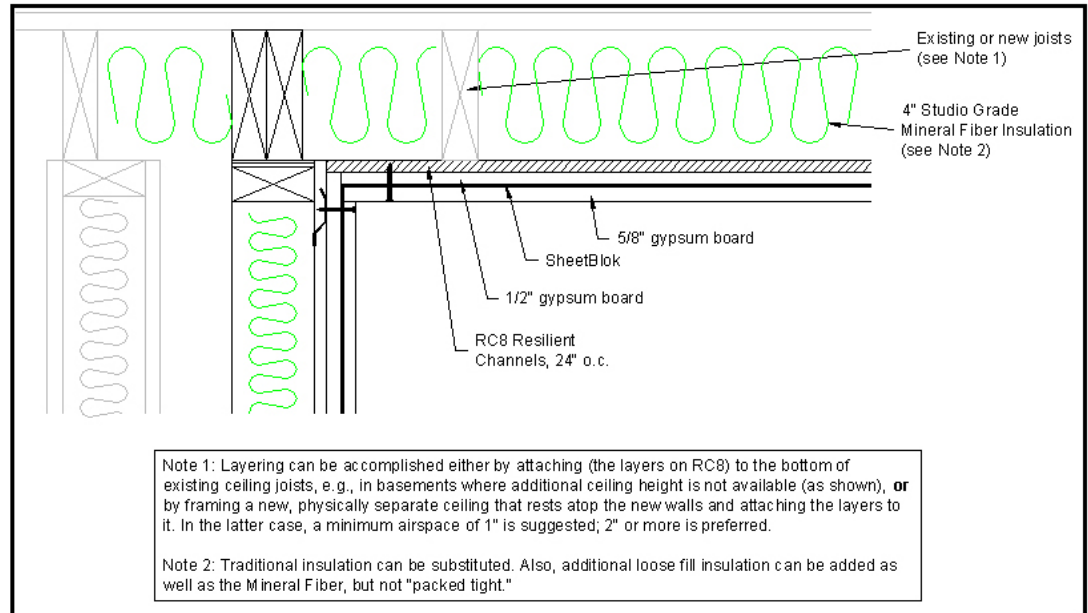

Figure 3.3a - Ceiling construction

height to spare, drop down 3½" and frame another ceiling resting it only on top of your new walls (which, in turn, might be on top of your new floated floor). Insulate it with [Mineral Fiber](#) and cover it with two (2) layers of 5/8" gypsum board mounted on *RC8*. If you have an unfinished existing ceiling, insulate it with *Mineral Fiber*, cover the joists with two (2) layers of 5/8" gypsum board mounted on *RC8* (you can use 1/2" gypsum board if you want, but 5/8" has been verified to be better if space, time, funds and motivation permit) and then drop down 3½" and frame your new ceiling.

In reality, most of us fall into the "I do not have the height to spare" category. If that is you, you should add a layer of *SheetBlok* to your existing ceiling and then add one (or two) layers of gypsum board (1/2" or 5/8").

Should you be in a situation where you need more sound isolation, but absolutely cannot add any more gypsum board, consider adding a layer of [SheetBlok Plus](#) mounted with our pressure sensitive adhesive. A piece of wood trim is recommended at each vertical seam and across the top and bottom of each piece of *SheetBlok Plus* due to its weight. If the black color does not match your decor, your *SheetBlok Plus* may be painted with high-quality latex paint (note that you may need to prime it first). In order to use it as a finish layer, obviously you should be very careful during installation so as to not nick up the *SheetBlok Plus*. By the way, while the pressure-sensitive adhesive (PSA) backing for the *SheetBlok Plus* is very strong, we definitely recommend some type of mechanical fasteners be used, too. Plastic cap nails, screws with grommets, furring strips at the edges, etc. have all been used with good success. Also, for standard *SheetBlok*, multi-purpose flooring adhesive is recommended because it is made for use with vinyl materials. We have not tried this type of adhesive ourselves, so do not yell at us if it does not work for you.

No matter which method you use, the less light fixture boxes set in the ceiling, the better: They serve as open windows to sound. Track lighting is preferred to recessed lighting and you should *StopGap* any wire holes as outlined elsewhere in **Acoustics 101** because holes sonically weaken a wall or ceiling. So much so that in some instances people have virtually wasted their time. Floor lamps or surface-mounted conduit may be your best bet.

(Non-)Flat Ceilings

Have you ever seen pictures of world-class studios? Sure you have. Have you ever seen one with a flat ceiling? Rarely, if ever. The reason for this is that it is widely acknowledged that rooms with more cubic volume (space inside them) sound better than small rooms. Why is this?

Small rooms tend to sound, well, small, because they have less space for sound waves to develop and breathe. Think about it. In a 10'x10' room, a sound wave that is traveling 1130 ft/s (feet per second) can get from wall to wall to wall to wall in no time at all. This effectively means the room does not allow time-delayed reflections to develop; reflections that would give the room a sonic "acoustical space" signature. Implementation of good diffusors (such as *Auralex T'Fusors™*) can definitely help a small room sound larger by properly diffusing the sonic energy in the room, giving the sound more room and time to breathe. Further, digital delays and reverbs have improved enormously over the last decade and we can now add our own "acoustical space" signatures to sounds — and best of all, *only*

when we desire to have them. It is often desirable to have a drier room and add ambience digitally rather than rely on the room to interject the ambience. The reason for this is that there are quite a few times when ambience is not desirable and other times when a different ambience than the room has is desirable. Still, there are plenty of instances where a room's ambient sonic signature is desirable. It is for this reason we started this talk about non-flat ceilings. Discussing room sound over lunch one time with Ross Vannelli, he hit the nail on the head: "Once it's on disk (or tape), there's no knob for it."

Few of us have unlimited budgets — budgets big enough to allow us to buy real estate with as much square *and cubic*

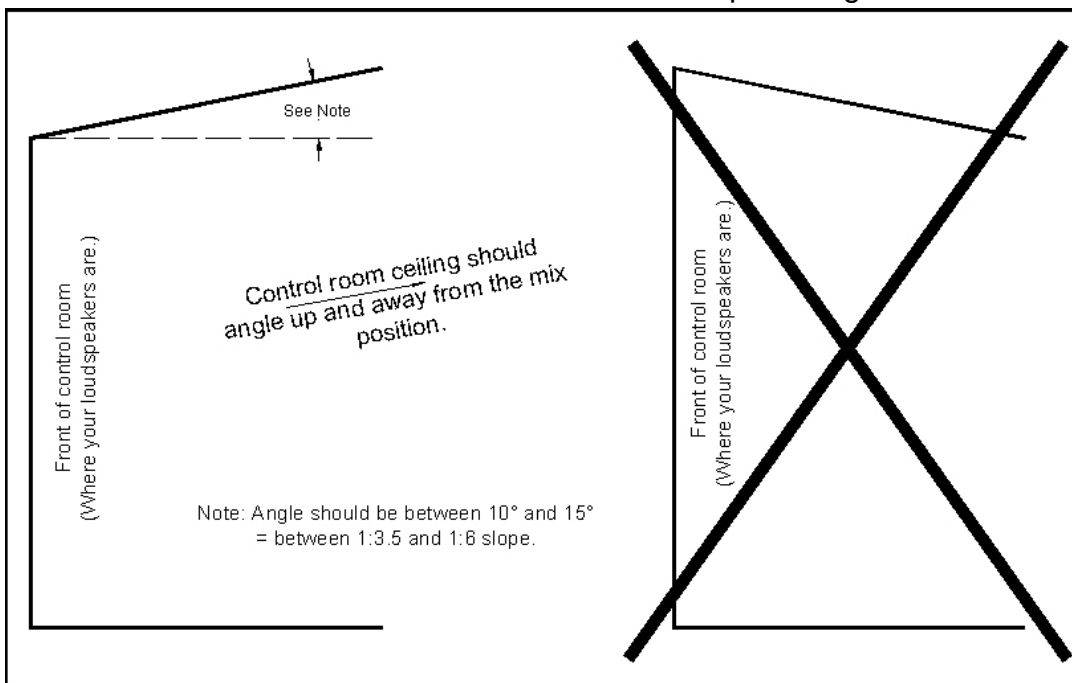

Figure 3.3b - Control room ceiling angle

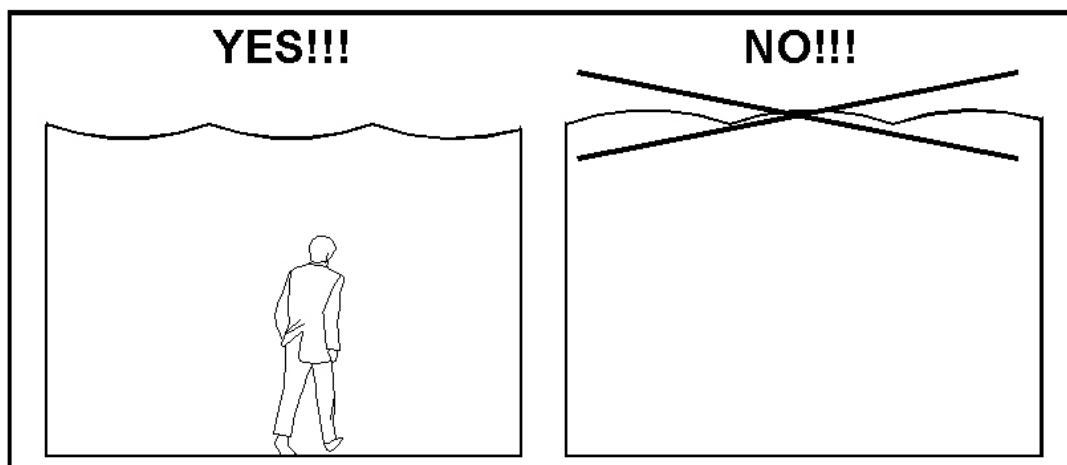

Figure 3.3c - Curved live room ceiling examples

footage as we would really love to have. Does this necessarily and always mean that we are forever resigned to suffer with tiny little rooms with flat ceilings? No way.

Square footage is expensive, but cubic footage is not. Look at Japan — what have they done? Because Japanese real estate is at such a premium (i.e. they have run out of it), they have chosen to grow *up* instead of *out*. We can put the Japanese principle to work for us in order to gain cubic volume for our rooms. Maybe to a relatively small degree, but we can gain some amount of useful cubic space to be sure. Non-flat ceilings are an easy way to do so. See *Figures 3.3b-c* for some examples of good (and bad) ceiling designs. Also note that “cathedral” or “A-frame” ceilings can be quite helpful in live rooms. (They are generally discouraged in control rooms due to focusing effects.)

Cathedral Ceiling Treatment for Live Rooms

Figure 3.4 shows an example of how we would suggest you to treat a cathedral ceiling for live rooms. This also would work in a control room or studio room you have put in, for example, an attic space because that’s the only place your spouse would let you! In it, we show [4" Studiofoam™](#) on the two ceiling surfaces that come together to form the peak of the cathedral ceiling. Below that (the farther down, the more effective it is), a horizontal piece of material forms the face of the “trap.” In this example, the face material is ¼" pegboard and it is covered on both sides with 4" Studiofoam. Instead of using two (2) separate pieces of 4" Studiofoam leading up to the peak, a viable and perhaps even more effective alternative is to span the peak with a piece of Studiofoam, forming a small, triangular-shaped airspace behind it. One way to control sound in general and low frequency sound in particular is to force the sound waves to fight their way through multiple layers of different materials and dead air before they can strike the room boundary.

You can also build the faces of these panels out of strips of 1x2, 1x3 and/or 1x4 lumber (normally pine, but that is your choice; based on your budget you might want to try oak or some other hardwood). One approach would be installing the slats in an alternating, random fashion (1x2, 1x4, 1x3, 1x3, 1x4, 1x3, 1x2, etc.) and leaving spaces of varying widths between them (¼", ½", ¾", etc.).

The last variation on this theme is to substitute plywood, masonite, or some other hard material

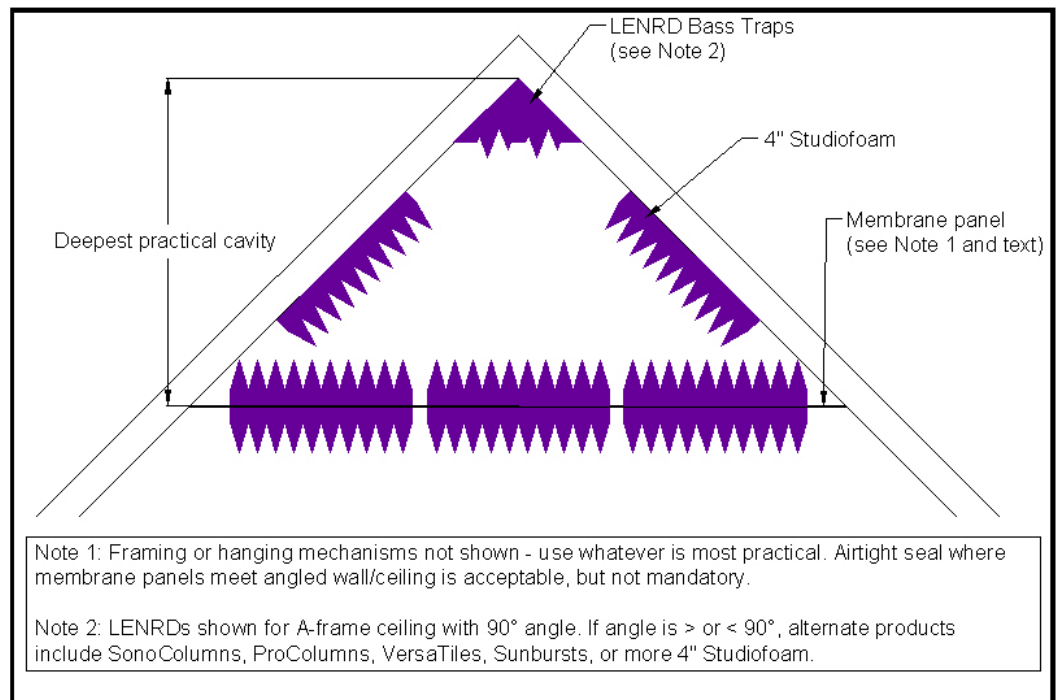

Figure 3.4 - Method for treating a "cathedral" or "A-frame" ceiling

for the pegboard, caulking the it tight to the ceiling surfaces so you end up with a sealed, resonant air cavity. This is technically known as a *diaphragmatic* or *panel* absorber. You can cover the face of the plywood with Studiofoam to broaden the effective range of the trap and help control your room’s

acoustics. The *Studiofoam* inside the trap broadens the range of frequencies the trap affects, kind of like changing the Q of a parametric equalizer.

The preceding three paragraphs have described perforated panel absorbers, slat-Helmholtz absorbers and diaphragmatic absorbers, respectively. For more information on exact designs of these devices – designs that will help you tune them to target a specific frequency range – please refer to the titles – particularly the *Master Handbook of Acoustics* by F. Alton Everest – on our [Book Referrals](#) page. Many of the titles are probably available through your local library.

Using any of these methods is viable; which you use is really up to you and depends on how much time you want to put into the device(s). They all work, so just pick one depending on your needs. Some people have even combined a couple of these variations. For example, wooden slats can be placed over the face of the plywood for extra reflection and diffusion.

An often overlooked method of gaining extra bass trapping in a small room is to "steal" some of the wasted space that may be above an adjacent room. Famous acoustician and talented surfer dude Chris Pelonis (who has used *LENRDs* when 90° angles are involved) has built Helmholtz resonator types of bass traps in the attic space over rooms adjacent to studios and control rooms. This is a great way to give a room's low frequency waves more room to develop and breathe and to utilize what is often wasted space. *Auralex* implemented this type of adjacent trapping in our acoustical design of the 1999 *CEDIA Home Theater of the Year* and the room tested flat ($\pm 3\text{dB}$) from 70 Hz to 20 kHz. Down to 38 Hz, the room was subjectively flat; i.e., it had no audible peaks or dips. On paper, this corresponded to $\pm 6\text{ dB}$ down to 38 Hz. See the [SJPT Case Study](#) for more details.

Mr. T (Bar)

Many times a customer with an existing T-bar (suspended, or "drop") ceiling will ask if he should remove it to expose the bare gypsum board ceiling above, then treat the gypsum board ceiling with foam. If the existing ceiling tiles are the really cheap, not-very-absorbent type (the absorption coefficients and NRC of which you might be able to verify with the help of your local hardware store or lumber yard), then we would say "yes." If the existing ceiling tiles' acoustical properties are able to be verified and the NRC is 0.75 or above, leave them, but over the top of them and the T-bar roll out at least one layer of 4" *Mineral Fiber* or 6"-12" unfaced traditional insulation. Doing so not only helps alleviate the reflected sound that can bounce around between the top of the suspended ceiling and the gypsum board above, it improves the NRC of the ceiling as a whole, especially with regard to its low frequency absorption. It is also likely to marginally improve sound isolation from whatever is above the room, be it a neighbor or the great outdoors.

If you are in a space that has an existing drop ceiling that has decent NRCs, but you desire absolutely the maximum amount of sound transmission loss from above and are absolutely unable to frame a new false ceiling, we have a couple solutions for you. The first involves rolling out unfaced insulation or *Mineral Fiber* as noted above then rolling out *SheetBlok* over the top of the insulation. *SheetBlok* weighs 1 lb/ft², so some reinforcement of the T-bar suspension will probably be necessary. Overlap the *SheetBlok* by at least an inch, then tape the seams with foil duct tape or at the least regular cloth duct tape.

Alternatives:

- Cut *SheetBlok* to the size of each of your ceiling tiles, then glue it to the back of each tile or simply lay it over them.
- Buy [T'Fusors™](#) and lay a piece of rigid material like 1" *Mineral Fiber*, [SonoFiber](#), or even rigid glass fiber board (preferably with *SheetBlok* cut to fit and glued to it) in the cavity molded into

the back of each *T'Fusor*. This yields improved diffusion, quite a bit of low frequency trapping and improved isolation.

Some suspended ceilings are not the sturdiest things, so be sure to check yours out and make sure it will support the weight of the composite panels before you go ordering the materials. Nothing ruins a session like a heavy ceiling crashing down on top of you!

If you feel the need to install a suspended ceiling in a room where there is not one already, the tile manufacturers recommend that it be dropped down from the existing ceiling 16" to 18" for the best acoustic performance. We agree, especially if you implement the insulation over the top of it as described above. Some ceiling tiles we would encourage you consider – in lieu of the “cheapies” you get from the hardware store – are as follows:

- *Armstrong* High-NRC tiles include [Optima Open Plan](#) and [Painted Nubby Open Plan](#).
- *USG* High-NRC tiles include (PDF downloads) [Orion 270 ClimaPlus](#) and [Premier Nubby ClimaPlus](#)

For those of you sharing space with neighbors, especially in commercial settings, a commonly overlooked route of sound transmission is the space above the drop ceiling and over the wall separating you from your neighbor. Many times this area will be totally open, so the only things stopping sound from your neighbor getting to you (and vice versa) are your and your neighbor's ceiling tiles. This will typically provide an STC of only 10-15. Grossly inadequate for sound isolation – especially a studio! There are two main solutions to this problem:

1. Replace your ceiling grid or – ideally – both ceiling grids with a solid, drywall ceiling as described above.
2. Continue the common wall up to the roof or floor deck above, seal it airtight, and possibly consider adding to its construction as outlined below in the section on **Walls**.

At the very least, *SheetBlok* hung vertically above the wall and sealed as tightly as possible to the structure can help. The more airtight the better, so grab your caulking gun and go wild.

If you have already leased such a space or are contemplating doing so we would encourage you to bargain with your landlord; ask him to share the expense of making the space habitable for your needs. Many landlords will step up; a landlord who is in it for a quick buck will not and will likely be tough to deal with down the road.

WALLS

Unfortunately, the basic walls built in most homes and businesses are simply not dense enough or thick enough to be good barriers to neighboring sound. This page will show you proven methods for adding additional layers of materials to your existing walls to make the most of them. For those of you doing new construction, these tips are applicable as well. The choice of how to retrofit your existing walls, ceiling, etc. is entirely up to you, your ears and your pocketbook.

Existing Walls

First, determine as best you can what the materials are which comprise your existing walls. You *hope* you find out that you have 2x6 walls, heavily insulated and caulked, floated on *SheetBlok*, then covered with a layer of 5/8" gypsum board, a layer of *SheetBlok*, a layer of 1/2" gypsum board and surface treated with *Studiofoam*.

If so, go directly to Park Place, collect \$200 and have dinner at a fancy restaurant. If not, read on.

If your problem sounds severe to you and you learn that the existing wall has no insulation in it, it is advisable to install *Auralex Mineral Fiber* in it by removing the gypsum board and placing the *Mineral Fiber* between the wall studs. Alternatively, you can look into blowing insulation into the wall with a machine (see your local hardware store for details).

Having done that, the more closely you can retrofit your wall to resemble the one shown in *Figure 3.5* above, the better off you will be. You can choose to alter materials or leave off layers, but the performance of the wall may be lessened, so delete or change at your own risk. Naturally, you should use good construction techniques, taping, mudding and caulking seams all the way, making sure to stagger all seams and rotate adjoining layers 90° from each other.

If you determine your problem to be relatively minor, you might be able to get by with as little as adding one (1) more layer of gypsum board. If you previously found out your existing wall is one layer of ½" gypsum board or plaster on lathe (older homes), add a layer of *SheetBlok* and then another layer of ⅝" gypsum board.

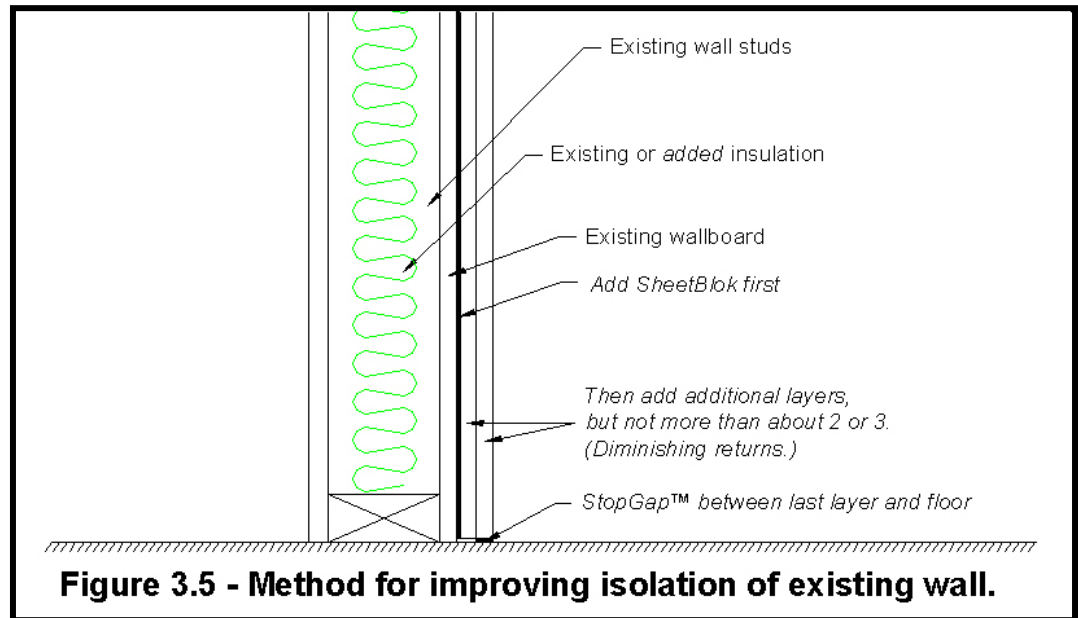

Do you want to go to the trouble to fur out from your existing wall to hang your new wall boards on? We think so. It is neither a waste of time nor money and, if you have both, we would encourage it...but with a twist. *At least* cover the faces of the furring strips with strips of *SheetBlok* (it is considerably more effective to actually mount a layer of *SheetBlok* across the faces of the furring strips versus just putting strips of *SheetBlok* on the furring strips' faces, but it also costs more). Then mount *RC8* across the furring strips. Then mount a layer of ⅝" gypsum board to the channels.

Construction

If you have the opportunity to build your space taller, allowing for a false/lowered ceiling and giving your studio more cubic space, then you are indeed lucky. If that's the case, there are a few things to note that you might implement to improve on the wall/ceiling described above.

- You should definitely build a "room within a room," meaning that there is air space and no physical contact between the exterior walls and the new walls of your studio! There is no substitute for doing it this way. You can build just one wall and can add layers to the wall until you are blue in the face and poor as Patty's pig, but chances are that you will never achieve the level of sound transmission control you will if you go the extra mile and build a room within a room. You know what they say about an ounce of prevention being worth a pound of cure? In the practice of acoustics, an ounce of prevention is worth *considerably more than* a pound of cure!

- Sound can slip through very tiny gaps (1/32" and smaller) which might seem to you to be insignificant. So it is of *extreme importance* to construct your place as airtight as humanly possible. When humanly possible is not good enough, *StopGap* can be of great benefit. The specific gaps we are talking about here are, e.g., the gaps around electrical boxes (remove the outlet and switch plates to find them), underneath door trim, baseboard, crown-molding, around HVAC vents (remove the grilles to find them), and so on. This is all part of the attention to detail we've been talking about!

- Never mount electrical boxes or connector panels back to back; always stagger them as shown in the *Figure 3.6*. Seal the holes your wires go through, or (preferably) run wire through conduit, stuffing foam or insulation in the ends to help seal it. Isolating the conduit from the structure with *SheetBlok* or hanging it with resilient hangers can really offer some improved isolation. Remember: *Sound control is a game of inches.*TM

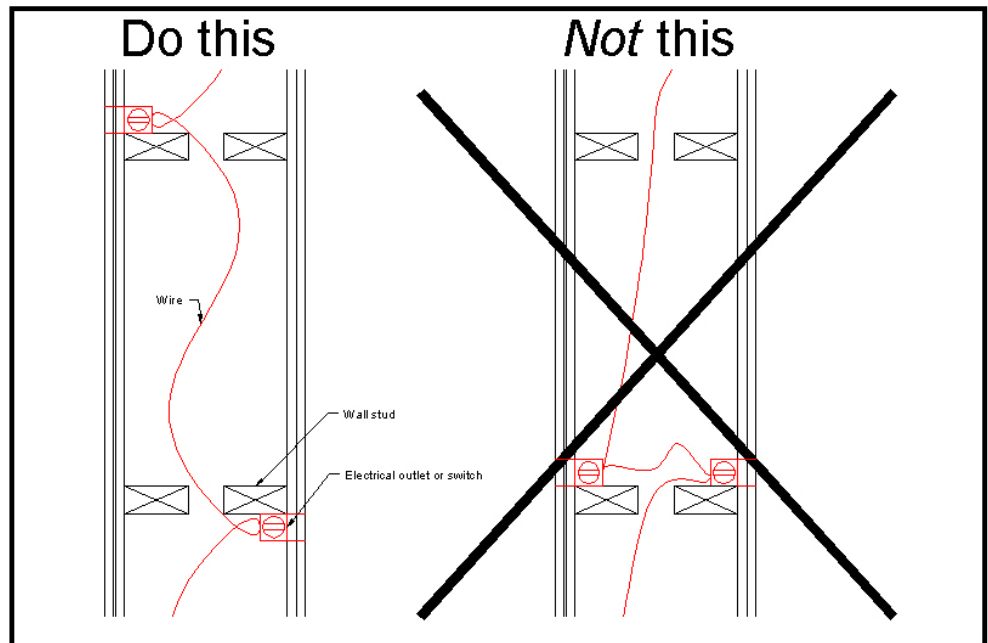

Figure 3.6 - Placement of electrical boxes, e.g., outlets and switches
(Note: Top view of walls. Insulation in walls not shown for drawing clarity.)

- Of course, the less wires and boxes you have poking holes in your walls, the less chances sound has to get through where you do not want it. It may be prettier having all your boxes flush mounted, but there is a lot to be said for surface mounting your phone cables and jacks, audio connector boxes, light switches, etc. Not only does this method yield better isolation, your artsy friends might consider you "retro", "industrial" and just plain "cool." *Studiofoam* and other *Auralex* treatments applied to room surfaces can often mask surface-mounted goodies.
- It is always better to keep wires away from each other than in big globs; especially audio, video, data and phone lines that might be in proximity to electrical wires. If wires have to cross, doing so at a right angle lessens the chance of interference occurring. Otherwise, keep all the different types of wires at least 12" away from each other and use shielded cable wherever possible.

Other than the above, the wall construction we generally suggest is shown in *Figures 3.1a-b* from the section on **FLOORS**.

CHAPTER 4

DOORS

Isolation

The best common doors to use are exterior grade, solid-core wood (“slab”) doors that are flat, without moldings. Also common, but more expensive, are commercial and/or exterior grade insulated steel doors.

You can add *SheetBlok* to one or both sides of either type of door before installing the knob to provide additional transmission loss, then *Studiofoam* over the *SheetBlok*.

If you have the inclination, you can make a door sandwich out of two (2) solid-core doors and a couple layers of *SheetBlok* in the middle (this is the sort of thing *Eddie Van Halen* did at his *5150* studio). If you desire to have the ability to lock your door, be sure you can find a knob/lock that will work with your thicker-than-normal door.

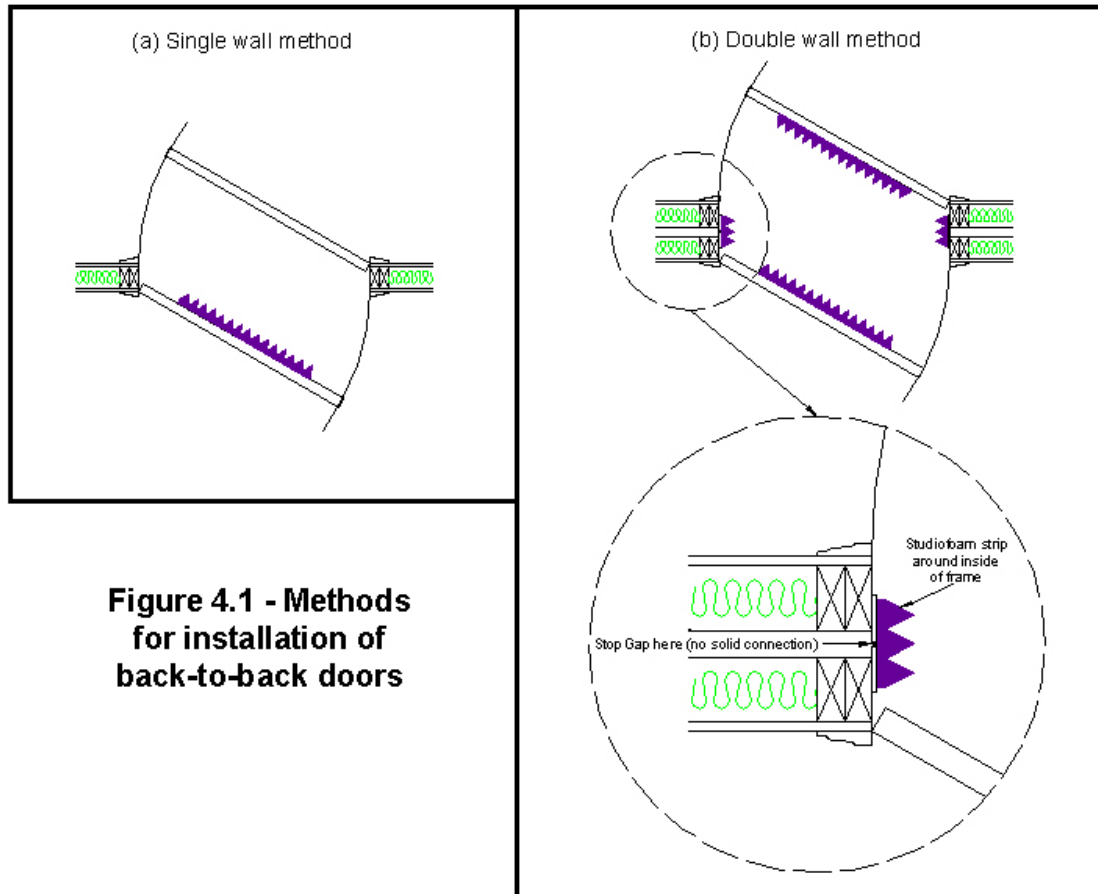

Figure 4.1 - Methods for installation of back-to-back doors

Double doors (back-to-back) are of some benefit if they are (a) attached to physically separate door jambs that are floated, and (b) are as far apart as possible given the constraints of your framing structure. Build your walls and double doors in such a way as to give you as much dead air space between the doors as possible. *Figure 4.1* shows methods of installing back-to-back doors for single and double framed walls. Alternate your door knobs and hinges left to right. You can add

surface moldings to your slab doors if you want to dress them up. Install *Studiofoam* on your doors – especially the sides that face each other. This absorbs any resonance that might occur between them.

The biggest reason that doors are poor in the area of sound control often has little to do with the physical construction of the doors themselves (if you are using one of the types outlined above). The weakest link in most door systems is that they are not sealed well with the floor below them or with the frame around them. You *must* use a compressed rubber threshold below your door and you *must* make sure that wherever the door shuts and would normally contact the door jamb it meets foam

weatherstrip tape or a rubber gasket. Magnetic seals can also be used, like you would find on a refrigerator door.

For those requiring the *ultimate* in door seals, you might contact [Zero International](#). They specialize in door seals that do a fantastic job of blocking sound.

If you are looking to save yourself a considerable amount of time (and headaches), you might consider simply specifying some sound-rated doors right into your studio. While they are expensive, sound-rated doors give you far superior performance to anything you could do with a single door on your own. Manufacturers of high-quality acoustical doors include:

- [Industrial Acoustics Company](#)
- [Overly Door and Window Company](#)

At most, you can expect an STC-30 to 32 from even the best solid-core door. The best double-frame, back-to-back solid-core door arrangement rarely yields better than STC-50. By contrast, typical single-leaf doors from the manufacturers above can yield ratings of STC-55 and higher. Worth considering if maximum sound isolation is your goal.

Garage doors

The concept of the overlapping doors spoken of and diagrammed above is easily adapted to a solution for leaky garage doors, especially if you break down the solution into multiple "bi-fold" type doors that seal well where they meet. The better solution, however, is to build a false, floated wall next to the garage door that does not come into contact with it and is isolated as well as possible from the existing structure using the methods described in **CHAPTER 3**. If your budget permits, placing a layer of *SheetBlok* over the interior face of the door before framing your new wall is advised. Most garage doors leak water, so you might want to raise the garage door the width of a 2x4 and then nail a treated, weather-resistant 2x4 under the garage door (floating the 2x4 with *SheetBlok* and sill seal, available at your hardware store) and caulking with *StopGap* where it meets the concrete, door frame, etc.). Having done that, lower the garage door down to it and nail up a 2x4 above the top interior edge of the garage door to keep it from being raised. You are then protected from water and thievery and everything you have done can easily be removed in the future should you or a subsequent property owner desire.

Airlocks

Many of you will be building studios in your basement and sound traveling up your stairwell may prove to be a problem. If possible, enclose your stairway and put a good, solid-core door at the bottom to keep most of your sound out of the stairwell. In addition, or if enclosing the stairway just is not feasible, apply as much 4" *Studiofoam* in the stairwell as possible to absorb as much ambient sound as you can, thus making less sound available to travel upstairs. Stairwells tend to resonate quite a bit, so if you are enclosing and adding a door, do everything you can to float or at least really bulk up your new construction. If building an airlock or "sound-lock" (a small room separating one sound-critical space from another and into which each of those rooms' doors opens), float everything you can, use *SheetBlok* copiously and treat the walls and ceiling with the thickest *Studiofoam* you can afford. If you have the know-how to build a window into the door – or you can afford a sound-rated door with a window built-in – this sound-lock can often serve as a vocal or isolation booth.

WINDOWS

Exterior

Often, it is relatively easy to add in a second window if you are already building a second wall. If you are going to do this, i.e., install a second pane of plate, insulated, or laminated glass, make sure the panes are as far apart as possible, are parallel to each other, and never touch wood framing of your new wall. The windows should only come into contact with *SheetBlok*, foam weatherstrip tape (*FrostKing* 3/4" wide by 7/16" thick, closed-cell, heavy-duty, interior/exterior recommended) or *StopGap*. You can either route out grooves for the glass to fit it or just block it in with small wood slats. Line the frame of the air space with Studiofoam to absorb standing waves and throw some packets of silica gel in between the panes to absorb the condensation that invariably forms there. See the [Interior](#) section below for more information.



Figure 4.2 — Clear SheetBlok™ in use at Perfect Sound Studios

Examples of exterior window isolation:

1. We recently helped drummer-extraordinaire, *Kenny Aronoff*, design and construct his new studio. Kenny had already purchased and installed some decent windows, but was concerned that they might not be as soundproof as he needed them to be. We sent a couple members of our Engineering department down to Kenny's place and were pleasantly surprised when his testing showed that the windows were "soundproof enough."
2. Around the same time, we helped *Joe Kasko* with his new facility, *Perfect Sound Studios*. (As it turns out, Joe is actually a friend of Kenny's. Small world!) When we were brought into the project, conventional windows had already been installed. They were not quite good enough to prevent sound from leaking out and bothering the neighbors behind the studio. In lieu of trashing the windows and losing the investment that had already been made, *Auralex* personnel devised – and Joe implemented – some "plugs" for the window openings using *Clear SheetBlok*, 1x3s and other materials. The results were great and our testing showed that they cut the level of sound transmission dramatically. When installed, the window plugs still afford the ability to see outside as shown in *Figure 4.2*. (But not perfectly because *Clear SheetBlok* is not as perfectly clear as glass).

[Worth noting is that *Perfect Sound Studios* has implemented the full *Auralex* arsenal from construction products to absorbers and diffusers (some of the coolest painted *T'Fusors* we have seen). The place looks and sounds awesome!]

Interior

A double window between a control room and a studio is often used because single-paned windows are very poor at stopping sound. You want to try to keep the panes parallel to each other to maximize the dead air space between them and you do not want to use three panes because using three panes actually *lessens* the contiguous dead air space. If you must angle your glass, angle only one pane,

not both, and make it a slight angle going up, as shown in Figure 4.3. Note that if you cannot angle the glass by at least 8°, you are probably wasting your time anyway.

No matter how you decide to construct your window, a good way to really clean your glass prior to installation is to mix 1 drop *Ivory*® dish soap gently with one (1) gallon distilled water. Or just use a *Windex*®-type glass cleaner. Do a good job because you are going to have to live with any smudges for a long, long time! Wearing cotton or rubber gloves while installing the glass is recommended.

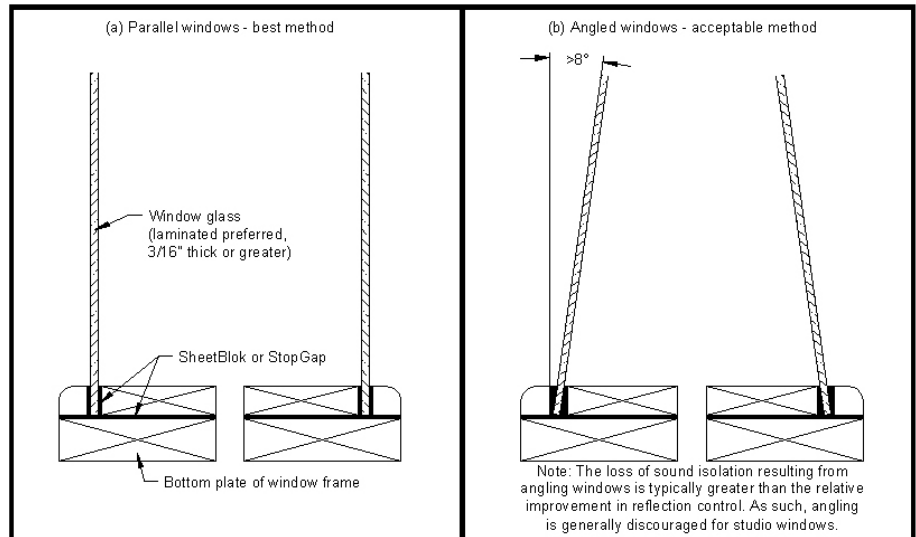

Figure 4.3 - Interior double-window construction

Figure 4.3 shows the preferred method of constructing your double-paned window. Make sure glass never touches wood and float the whole construction on *SheetBlok* to isolate it from your control room and studio walls. Throw a couple packets of silica gel into the dead air space to absorb unwanted moisture that could fog your windows. Line the inside perimeter of the dead air space with *Studiofoam* to help cut down on resonance.

And just so we are all on the same page in terms of the different types of glass:

- Plate glass is simply a solid piece of glass. This type of glass typically has the worst performance in terms of sound isolation.
- Insulated glass is actually two (2) thin pieces of plate glass separated by an airspace. There is an airtight frame around the glass and this type of glass is a pretty good performer in terms of isolation. You can also find insulated glass that fills the space between with an inert gas like argon. This does offer you an advantage since the speed of sound in argon is different from that of air. This is known as an *impedance mismatch* and can give you a slightly better STC.
- Finally, the best glass performer, in terms of sound isolation, tends to be laminated glass. Laminated glass is much like insulated glass, except in lieu of a airspace, there is a laminate – i.e., a clear glue. This is an even better impedance mismatch than that provided by the insulated glass. We strongly encourage the use of laminated glass for any studio.

A final note about glass block: Glass block is often desirable when natural light is welcome, but prying eyes are not. Glass block tends to be a great sound performer. There are typically two varieties: Solid block and hollow block. The neat thing is there is not much of a performance difference between the two because the hollow block is actually evacuated. This happens when the two pieces of glass are superheated to fuse them together and form the hollow block. The air trapped inside the cavity is also at thousands of degrees when the block is formed. As it cools, the volume of the cavity is constant, but the temperature drops considerably. When this happens, the pressure drops to next-to-nothing (*Boyle's Law* for you propeller-heads), which we call, for all intents and purposes, a *vacuum*. Since sound cannot pass through a vacuum, this is very advantageous for sound control. For some great

choices in sound-rated glass block, we highly recommend the products manufactured by [Pittsburgh Corning](#).

HVAC (HEATING AND COOLING SYSTEMS)

HVAC stands for “Heating, Ventilation and Air Conditioning.” To control noise in HVAC systems requires attention to many, many details. You should note that with regards to minimizing HVAC noise, we *can* guide you along the right path. However, we do not pretend to know how to design the right HVAC system for your studio with regards proper comfort, temperature and humidity control. If you are very serious about controlling noise in your HVAC system, one thing to consider is hiring an expert versed in the *American Society of Heating, Refrigeration and Air-Conditioning Engineers (ASHRAE)* guidelines on HVAC noise control. Alternatively, you could order the (very expensive) *Handbooks* and educate yourself. Of course, we will attempt to summarize here the many concepts covered by *ASHRAE* and other experts in the field of HVAC noise control.

Whether you are in the process of building a studio, or converting a room into one, chances are the question of how to heat, cool and/or ventilate it has crossed your mind. There are a few important things to remember with HVAC and studios:

1. Even if you do not need heating or cooling, you need ventilation. People need to breathe and they need to breathe the freshest air available. Stale air cannot only give a “bad vibe”, but it can be unhealthy. Even if you are fortunate enough to live in a fairly temperate climate, airflow is going to be essential for maximizing the studio experience.
2. HVAC noise can ruin recordings. There is nothing more unprofessional than tracking with a “hiss” or “rumble” of a poor HVAC system in the background. You hear a lot in our industry about “signal to noise ratio”. This often refers to gear and how much electrical noise is introduced into the signal chain by a device, such as a preamp. HVAC contributes a different kind of noise. Noise that cannot be reduced by buying a more expensive DSP.
3. Location for HVAC can affect sound. Research has shown that even small temperature gradients in studios can cause imaging problems. Improper location of air duct openings can inadvertently screw up an otherwise top-notch mixing environment.

Some of the advice that follows in this section is common sense. Some will only make sense to your HVAC designer/installer. We are basically going to follow the “signal chain” in terms of airflow. Thus we begin with...

The Air Handler

In most residential cases, this is your furnace, air conditioner or heat pump. (Or perhaps a combination of one or more of these.) From here on, we will refer to all of them using the general term – *air handler*. When selecting the proper air handler, it may surprise you to find out that bigger is *not* necessarily better here. But neither is smaller. It is very important to select an air handler that is sized exactly for your airflow needs. This will ensure it operates at optimum efficiency. And an efficient machine is a quiet machine. If you are adding on new ductwork to an existing air handler in your home, you should consider contacting an HVAC expert to make sure you are not overloading your system. In cases where you are building into a basement, this is probably fine, as the air handlers put on the home should already be sized correctly. If you are adding onto your home, though, you might be asking the air handler to do more work than it was required to do.

The above assumes that the location of the air handler is already fixed. If you are doing a complete build-out of a studio, you need to consider the three things (borrowed from real estate) that matter for low noise HVAC: Location, Location and Location! Put the air handler in a room that is physically as

far away as possible from anywhere you will have open microphones or where you will be doing any critical listening.

Another common feature in studios is the “window unit.” While window units are not recommended in general because they require a window or some opening in the studio that could let sound in or out, sometimes there is no other choice. We have yet to find a “silent” window unit, per se. However, the GE *Zoneline*® series of air conditioners tends to offer a wide selection of quiet units.

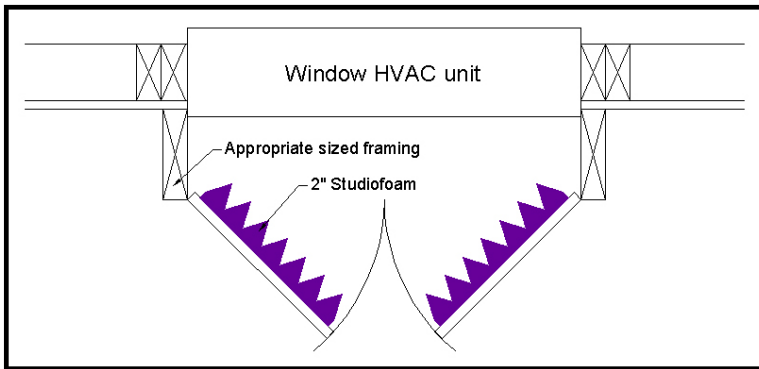

Figure 4.4 - Method for constructing a window HVAC enclosure

Of course, if you are on a limited or non-existent budget, try turning off your thermostat when you know you are going to have open microphones so the HVAC does not kick in at a crucial time. If you are cooling your space with a window air conditioner, you might also consider constructing a “trap door” or temporary cover that can be opened at will. As shown in *Figure 4.4*, it is crucial to isolate the frame from the wall and from the doors by using *SheetBlok* at the junctions or lining them with foam weatherstrip tape. The doors should be routed at the closing junction

so they overlap and this junction should be lined with weatherstrip tape. Instead of making the frame one layer of material, two (2) layers of different materials glued together is beneficial (if space permits), especially with *SheetBlok* between them. Should you desire the frame to be removable, it can be attached to the wall with angle irons (L brackets). Do everything you can to isolate the frame from the wall and the doors from the frame.

The Fan

The fan (a.k.a., the “blower”) inside your air handler tends to be the single largest producer of noise. (Except the compressor. But the compressor is usually located outside, on a roof or in a crawl space. If there will be a compressor near your studio, make sure it is in a separate, well-isolated room.) You should have already gotten off on a good foot if you selected an air handler of the correct size for your application. The other thing to find out is if the air handler comes with, or can be equipped with an *insulated plenum*. Most residential units do not come with this sort of feature or option. It might be possible, however, for your HVAC expert to help you design a large box in or attached to your air handler between the fan and the supply and return ducts. This box should be larger than the supply or return air opening and should be lined with (minimum) 1” thick *ductboard* or its equivalent. Think of this like putting a big muffler on your air handling unit. This plenum will absorb noise from the fan and its motor.

Connections

Connecting the air handler to the duct work requires a little more than a pair of tin snips if you want to minimize noise. Your HVAC expert should be able to help you select the correct *flexible connections* to put between the air supply and return and their respective main ducts. These types of connections are essential to help prevent vibrations from the air handler from traveling down the duct.

Ducts

Ducts carry the air to and from your air handler. Most homes have a branching supply system with a large, central “cold air return”. Commercial spaces will rarely have a ducted cold air return. More

often, the air is simply sucked up through the *plenum*, i.e., the air space above an acoustical ceiling. (This is not the same as the *plenum* described above for quieting the air handler fan.)

For any ducted system, some key things to keep in mind:

- Over-sizing the ducts is a good practice. If you have an HVAC expert in the loop, he/she will have figured the airflow required for each room in “CFM” (cubic feet per minute). To find out what size you should make the ducts, divide the CFM by the cross-sectional area of the duct in square feet (ft²). Example:
 - 500 CFM required.
 - 12” round duct yields $\pi \cdot (0.5)^2 = 0.785$ ft² (remember $\pi \cdot r^2$ is the area of a circle and 0.5 feet is the radius of this particular duct example)
 - Therefore, the air flow velocity will be $500/0.785 = \sim 637$ FPM (feet per minute)

Any result you get for the above under 1,000 FPM is good. Below 500 FPM is excellent.

- Use round ducts for minimal low frequency noise. Use round, insulated ducts for minimal low and high frequency noise. Use round, insulated, flexible ducts for the best results, but do keep in mind that since there is no sheet metal, sounds could “break-in” to the ducts from spaces they are passing over or through.
- Avoid very sharp bends in the ducts. Where bends are necessary, make sure they are gradual and – if possible – include long, radiused *turning vanes*.
- If the ducts are sheet metal, you may need to isolate them from the building using isolating hangers. (You can *Google* this to find some vendors.)

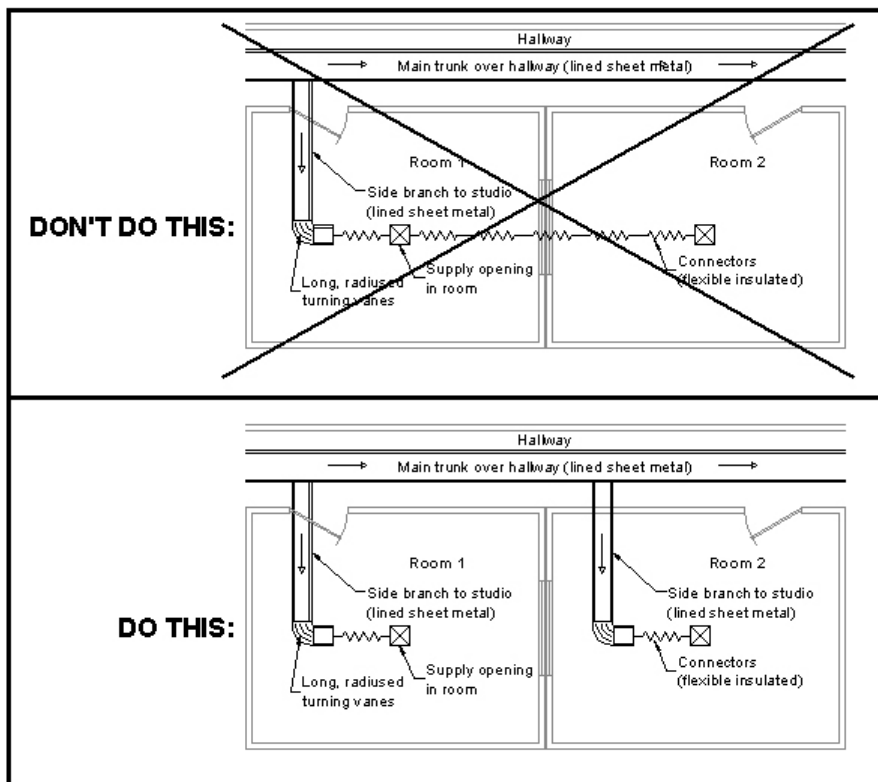

Figure 4.5: Method to properly interconnect HVAC systems between studio rooms (“daisy-chaining” is strongly discouraged)

- Do include some bends between the air handler or main trunk and the studio room. Bends reduce noise, but only if they are gradual and preferably equipped with turning vanes.
- If installing a new HVAC system and ductwork, make sure that you do not have ducts “daisy-chaining” between adjacent studio rooms that are fed by the same main trunk. Instead, add an additional trunk line and feed each other room as shown in *Figure 4.5*.
- If you do your wall construction appropriately, you might even consider terminating your duct into the space between two wall studs, which you can line with fiberglass board, then venting

that space into the room. We have seen this done and it proved to be very quiet!

- Where the duct normally terminates in the wall or ceiling opening, consider an oversized *boot* instead. Some pictures of a *ductboard* boot we built for one of our labs are shown in *Figures 4.6a and b*. We used 6" round, flexible, insulated duct that terminated into a *ductboard* box roughly 17" long x 12" wide x 13" deep (into the ceiling). The whole boot should be caulked airtight and isolated from the wall by *SheetBlok* or foam tape to keep from transferring mechanical energy to the wall and making it resonate.
- Finally, avoid putting ducts in walls shared with other noise sensitive or noise producing spaces. This will create a weak link in your wall construction.



Figure 4.6a — Silent duct boot, grille closed



Figure 4.6b — Silent duct boot, grille open

Terminations

The final links in the chain are the *air devices*. These are the “grilles,” “diffusers” (not the acoustical kind), “registers” and “vent covers” that go over the duct opening in the room. When considering devices like these – for supply or return air – you should try to find out the “NC” (“Noise Criteria”) rating for them from their respective manufacturers. These are noise ratings that the device manufacturer must provide for all possible airflow rates. For a studio, you should choose a device that has NC-30 or lower for the designed airflow rate. Actually, NC-30 is the highest you should consider. It should be quite easy to find a device that is “off the charts.” I.e., it doesn’t have a rating because it did not produce any noise when tested at your airflow rate. For a good selection of quiet air devices, check out on of our preferred manufacturers, [Titus](#).

Do not locate your terminations anywhere above the mix area, especially between your ears and your monitors, because moving air and different (even small) temperature gradients distort sound waves. This *will* skew your imaging.

ELECTRICAL ISSUES

Again, we would encourage you to hire an expert to help you with all aspects of electrical wiring and hookup in your studio. For electrical noise concerns, we offer some tips:

- House computers, amps – basically anything with fans – in a separate equipment room. Build this room just like you would build an isolation booth. The only thing to keep in mind is the cooling required by many electrical devices. (Otherwise, they wouldn’t need the fans.) So be sure not to miss the **HVAC** section.

- If you do not have the space for a separate booth, consider at least housing some of your noisy computers and amps in equipment from [Sound Construction and Supply](#), makers of the *Iso-Box*.
- If possible, install separate circuits to power your room(s), or even various components of your room(s) such as lights, HVAC, computers, audio processing, audio power amps, etc. While it is of supreme importance to keep all your gear tied to a common ground at the electrical panel, splitting things off on their own circuits lessens the possibility of various pieces of gear, lights, etc. from causing AC problems for each other.
- Avoid fluorescent lights because they can introduce noise into your room and into your audio systems. While dimmers, in general, are also to be avoided, we do have some information on quiet dimmers. We have compiled a [PDF of some dimmer discussions](#) that have taken place on [Syn-Aud-Con](#) and [Recording.org](#).
- Keep power lines and audio/video/phone lines away from each other and never parallel.
- Plug your gear into spike/surge/brownout protection devices and make sure your insurance policy covers your gear if lightning should take some of it out. (Phone devices and computers are especially prone to this; we have suffered these sorts of losses in the past.)
- Live near extreme RF (radio) interference? Ask your electrician about constructing a *Farraday cage*; basically a chicken wire or aluminum foil room within a room that ties to your ground rod (seek professional assistance with this so you do not toast yourself).
- To really clean up your ground buzzes and hums, and to greatly lower the overall noise floor of your productions, look into the balanced power conditioners and other helpful devices manufactured by [Equi=Tech](#), [ETA](#), [Jensen Transformers](#) and [Furman](#). Of particular note are the [Jensen white papers](#). The folks over at *Jensen* are very much of the same mindset as *Auralex*: We both believe that the problems for which we manufacture products are the last anyone thinks about – i.e., acoustical and electrical noise problems. Anyway, all the products from the manufacturers above do a fantastic job and can really save your fanny when your best grounding and isolation intentions go awry. Of course, if you do not have the money for them, [Ebtech](#) makes some wonderful 2-channel and 8-channel hum eliminators that really work well. We have used them in mobile and studio racks.

CHAPTER 5

MONITOR MOUNTING SOLUTIONS

Many times a studio owner will build a decent wall then sabotage himself by nailing up a shelf to support his “nearfield” loudspeakers, or “monitors.” The problem with this is the monitors generate high SPLs (Sound Pressure Levels), transmit the sound through their cabinets and into the shelf, then the shelf excites the wall and transmission throughout the rest of the structure occurs. So, if you must rest your monitors on shelves, do what you can to isolate the loudspeakers from the shelves and the shelves from the structure, such as covering the shelves with a layer or two of *SheetBlok* or *Platfoam*. If supporting your shelves with angle irons (which are not pretty if left exposed, but very functional and easily hidden with *Studiofoam*), place a strip of *SheetBlok* or foam weatherstrip tape on the back of each angle iron, then screw it to the wall, preferably using plastic wall anchors with your screws whether or not you are screwing into wallboard or directly into studs. The plastic anchors actually help filter the sound traveling through them.

Another monitor mounting solution is to suspend your monitors from the wall or ceiling by using rubber tie down straps and eye bolts. The eye bolts should be screwed into sturdy studs and into the monitor cabinets at sturdy points. From there, rubber tie down straps can be used to adjust the monitors to the required angles. The obvious advantage of using rubber straps instead of metal chain is that the rubber straps help better isolate the monitor cabinets from the structure. Please be careful doing this because we do not want – and are not responsible for – your monitors falling on your head.

If you intend to set your monitors on shelves that rest on or overlap the top of your console, it is important to not only isolate your monitors from the shelves with *SheetBlok*, rubber feet ([Radio Shack part # 64-2342](#)), or our highly regarded [MoPAD™](#) monitor isolation pads, but also the shelves from the console. Remember that everything resonates (vibrates) at a certain frequency – even consoles – thus producing unwanted sound. Also, do not forget to place *Studiofoam* pieces on the top of your meter bridge to stop those pesky early reflections.

For those of you who have large monitors that are to be flush or “soffit” mounted *in* your walls, the old school of thought about resting them on concrete-filled cavities has generally been debunked. These days we know that concrete is so dense it transmits sound very well, so it is better to simply build good, sturdy soffits, then place the monitors in them using the aforementioned methods to isolate the monitors from the soffits. The inside spaces of the soffits themselves can resonate, so damp them appropriately, by floating them from the floor and walls and by lining them with *SheetBlok*, then lining the soffits with *Platfoam* so your monitors are “wedged in.” Be extra careful when constructing your soffits to make sure the monitors are at precisely the same downward angle and precisely the same distance off the center line from your mix position because, as you may know, you and your monitors should form an equilateral (all sides the same length) triangle, otherwise you will forever think your channel balance is off. For more great help on soffit-mounting – including construction details – check out the [SAE Reference Material](#) site and click on the “Construction” link on the left side, then on the “Speakers” tab that appears at the top of the page.

ROOM DESIGNS

Angled Surfaces

It is fairly common for folks to think of angled walls when considering building a recording or broadcast facility. A common misconception is that angled walls can be of benefit in the control of room modes. Not so; you will still need “bass traps” in rooms with angled walls.

The good thing about angling is that it can certainly minimize instances of flutter echo (higher frequencies) if done correctly. It then becomes essential to know how to do angle correctly. Before we get into some suggestions there, let us point out that, in many cases you are going to be treating your room(s) with Auralex acoustic products. Our products will work whether you have angled walls (and ceiling) or parallel walls (and flat ceiling). So if you do not wish to go through the trouble, there is little need to attempt to alleviate standing waves and room modes with angled walls; our absorption and diffusion products are going to alleviate them for you. The main point is if you try to build an out-of-square room and get it wrong, you are going to be in a world of hurt and will end up spending more on building materials **and** acoustic treatments in the long run.

If you do not mind a bit of a challenge, here are some key things to note when angling your walls:

- For control rooms, symmetry is very important. One wall out-of-square is not a good thing.
- If the total angle of “splay” is not between 8° and 15°, you are wasting your time. E.g., your ceiling should be angled 8° to 15° from front (low, in front of you) to back (high, behind you). If you are taking two parallel walls and angling them in opposite directions to each other, do it equally with half the splay for each side. I.e., 4° to 8° on each side should be a design goal. For an example of this, we will be discussing the “Acoustics 101 Room” shortly...
- Finally, angling in two dimensions can do wonders for a recording room, especially for the ceiling. If you are considering something like this, a copy of [Philip Newell's Recording Spaces](#) should be purchased immediately.

Room Dimensions

If you are going to be constructing your room from scratch, one important thing to keep in mind is that the worst sounding rooms are always going to be ones whose three dimensions are all divisible by the same number, for example 24'x36'x12'. If you already have a situation like this, rest assured it is not the “end of the world.” Treating your room with *Auralex* products can take care of many of your room’s problems.

Now, if you are in a situation where you can design a room with good dimensional ratios, there is something you should keep in mind.

The ratios that are often published are a very small sampling of the many, many good room ratios and room dimensions you can implement. As an illustration of this, our Engineers recently wrote a program that would rank ideal room dimensions based on two of the most popular criteria. *Table 5.1* shows a small sampling of the results we’ve obtained so far. Should you have some dimensions, or

Table 5.1: Sample room dimensions that are "ideal" based on two commonly accepted criteria (c.f.)						
Eleven Studio Room Dimension Suggestions (Courtesy of Auralex)						
	L	W	H	L	W	H
A	226.00 in	162.00 in	84.00 in	574cm	411cm	213cm
B	218.75 in	182.75 in	90.00 in	556cm	464cm	229cm
C	253.50 in	182.50 in	96.00 in	644cm	464cm	244cm
D	252.00 in	209.00 in	102.00 in	640cm	531cm	259cm
E	293.75 in	206.25 in	108.00 in	746cm	524cm	274cm
F	301.00 in	217.75 in	114.00 in	765cm	553cm	290cm
G	302.50 in	218.50 in	120.00 in	768cm	555cm	305cm
H	342.75 in	243.25 in	126.00 in	871cm	618cm	320cm
J	359.00 in	257.50 in	132.00 in	912cm	654cm	335cm
K	343.50 in	285.75 in	138.00 in	872cm	726cm	351cm
L	354.25 in	296.75 in	144.00 in	900cm	754cm	366cm
Five Vocal Booth Room Dimension Suggestions (Courtesy of Auralex)						
	L	W	H	L	W	H
A	79.75 in	66.25 in	84.00 in	203cm	168cm	213cm
B	84.50 in	72.25 in	87.00 in	215cm	184cm	221cm
C	87.25 in	68.50 in	90.00 in	222cm	174cm	229cm
D	88.25 in	69.75 in	93.00 in	224cm	177cm	236cm
E	94.00 in	74.00 in	96.00 in	239cm	188cm	244cm
Note: Dimensions are not ranked - they are in order according to increasing ceiling height.						
Note: Ratios are deliberately omitted since a good ratio for one set of dimensions does not necessarily constitute a universally "ideal" ratio.						

ranges of dimensions you are considering you can either contact us and we will help you decide, or you can look check out the [studiotips.com forum](http://studiotips.com) where many useful tools are housed (and where many of the world's experts in home studio design, construction, etc. help people just like you every day!).

The Acoustics 101 Room

In previous versions of Acoustics101.com, you may have seen a rough sketch (plan view) of a room with angled walls and roughly drawn in acoustical treatments. Well, by very popular demand, we've taken that very general room concept and turned it into a PDF you can actually use. So if you are building from scratch and desire to build the best stereo mixing room you can without getting drowned by formulas and equations, take a look at the official Acoustics 101 Room PDF (see **APPENDIX 2**). When built as outlined elsewhere on this site, this shape – which is loosely based on dozens of million dollar rooms – will be about the best you could ever hope for if you are the type who likes a little controlled liveness in your control room.

Should you prefer a more neutral room – perhaps something along the lines of a “Hidley Room” or a “Non-environment,” you can simply replace the *T'Fusors* shown on the rear wall with thick absorption, such as [Venus Bass Traps](#). For more information on the “Non-environment” design, we would recommend [Philip Newell's Recording Studio Design](#).

5.1 Mixing Rooms

If you have been reading all the ink in the trades lately regarding top engineers mixing for release in 5.1 channel surround format and are considering making the move to a surround mixing setup yourself, there are some acoustic issues that must be addressed. Acoustically treating a control room to yield an accurate surround-mixing environment can be quite different from treating a “typical” control room in which stereo monitoring is performed.

In treating a stereo mix environment, we introduce large amounts of absorption at the front of the room to kill early reflections so the engineer hears only the direct sound coming straight to his or her ears from the monitors. We sporadically absorb the rear half of the room's side walls and sometimes ceiling to allow the rear of the room to breathe. We introduce broadband diffusion devices into the rear wall and rear ceiling area of the room to spread out the sound energy in the room without killing it, thus imparting a sense of space and envelopment at the mix position. The contribution from diffusion on the rear wall is not detrimental to the imaging and direct sound perceived at the mix position because the diffused sound should be arriving at the mixer's/listener's ears delayed enough in relation to the direct sound. Thus, the brain/ear mechanism is not confused by the diffused sound. (The minimum path length from loudspeaker to rear wall to listener is typically on the order of about 16'-20'. This means that if your front-to-back dimension is not at least 10' to 12', you are probably not getting your money's worth with any diffusion on the rear wall.)

Conversely, a 5.1 channel surround mixing environment requires that absorption be used to yield early reflection control at the room boundaries near all five surround loudspeakers, not just the front two used in a stereo mixing environment. Whereas 5.1 channel listening and mixing environments allow you to hear much greater detail in the program material, especially with regard to reverberation and other ambience, diffusion is not usually appropriate in these environments because it would make you think there was more ambience on your tracks than there really was and negate much of the painstaking work that went into the surround mix. Obviously this is not desirable. [Note that if you are setting up a room for 5.1 playback only (no mixing), you might benefit from diffusion at the rear of the room ***if*** you are using dipole surrounds.]

For the mixing environment, we advise room surface absorption all around (including the ceiling), a reflective floor and we also encourage the user to strongly consider beefing up the absorption materials used so that even, broadband absorption is achieved. Symmetry is *very* important when implementing the acoustic treatments in a room in which accurate 5.1 mixing or listening is to be performed. Extra low frequency absorption is advised due to the LFE (the “.1”) channel’s extreme bass output capabilities.

For more information on setting up surround mixing environments, we highly recommend either of the following articles:

- *Stop! You’re Surrounded* by Philip Newell, *Audio Media*, May 2001
- Surround Listening Environments – Acoustics Count by John Storyk, *Pro Audio Review*, June 2004

Other Resources

- If you would like to look through some plans (beside the Acoustics 101 Room) for building your recording studio, we would suggest the [SAE Reference Materials](#) site. Simply click on the “Studio Plans” link on the left side of the page.
- If you are serious about designing and building a full-blown facility from the ground up (and you have a **BIG** budget), *Auralex* can assist! We can provide a full studio facility design working in conjunction with the *Russ Berger Design Group* and would be happy to prepare a scope of work and fee proposal for you. [Contact us](#) for more information.

APPLICATION EXAMPLES

General Resources

Auralex already has a wealth of case-specific product application information available through the following resources:

[The Auralexian](#) – Monthly installments of specific problems we have helped our customers address using Auralex products.

[Featured Industry Profiles](#) – Some unique applications of products and some high-profile customers with whom we have worked.

Night Club Isolation

The Situation

A blues club with a residential apartment upstairs.

The Structure

Concrete walls, concrete floor, concrete ceiling with suspended ceiling tiles 18" down. While the client noticed less-than-ideal sound in the club, the main problem he wished to combat was the structureborne transmission of sound to the apartment upstairs.

Our responses were as follows:

Ceiling

Roll out 6" unfaced insulation over the top of the suspended ceiling grid, then roll out a layer of *SheetBlok* over the top of the insulation (or at least back each ceiling tile with *SheetBlok*). Alternately, roll out 12" of insulation over the top of the suspended ceiling if it is determined that the ceiling cannot

support the additional weight of *SheetBlok* even with reinforcement. Seal the juncture where the rolled out *SheetBlok* meets the structure by using the aforementioned tape.

Stage

Pull back the carpet and pad on the stage. Pull up the layer of plywood over the framing members (joists). Insulate between the joists with 6" of insulation to cut down the reflected sound under the stage. Line the bottoms of the joists with *SheetBlok* to isolate the stage from the structural concrete floor. Install a layer of *SheetBlok* on the floor of the stage itself, or at least a layer of 3/4" MDF and then a layer of 3/4" particle board, cross-seamed. Then lay the padding and carpet back down. If the pad is not 6# rebond, replace it with this type or *ComfortWear-200*, which will offer 5-7dB of additional sound isolation. The stage should be kept as physically separate from the structure as possible. For maximum control, build new walls adjacent to the existing walls as outlined earlier or at least add additional layers of gypsum board to the existing walls with a layer of *SheetBlok* then a layer of 5/8" gypsum board. The club owner was unwilling to do either of these, so we recommended he apply 4" *Studiofoam*, realizing that it would alleviate at least some of the low frequency sound that is offending the apartment upstairs.

Garage Isolation and Treatment

The Situation

A one-car 13'x19' garage; carpeted floor; 5/8" gypsum board walls; no windows; 1 36" solid-core door; acoustical tile ceiling at 8' height. The room is used to teach guitar and rehearse with guitar, bass, drums and drum machine.

The Problem

Excessive slap echo and reverb along with excessive low-end buildup due to drum kit being located in one corner. Owner not overly worried about sound transmission to/from the outside, but would like some additional transmission control.

Our responses were as follows:

- Roll out unfaced insulation over the top of the suspended ceiling tiles, thus increasing transmission loss through the ceiling while adding low frequency control to the room.
- Treat all four vertical corners with *LENRD Bass Traps*.
- Treat the walls with 2" *Studiofoam*, preferably cut into 2'x2' panels and applied in a staggered checkerboard pattern with space between panels, easily adapted so no two parallel walls are mirror-images of each other. This method yields improved absorption *and* diffusion without costing any more money. Coverage minimum for a room of this size and with this intended usage is 45%; 60-75% is more

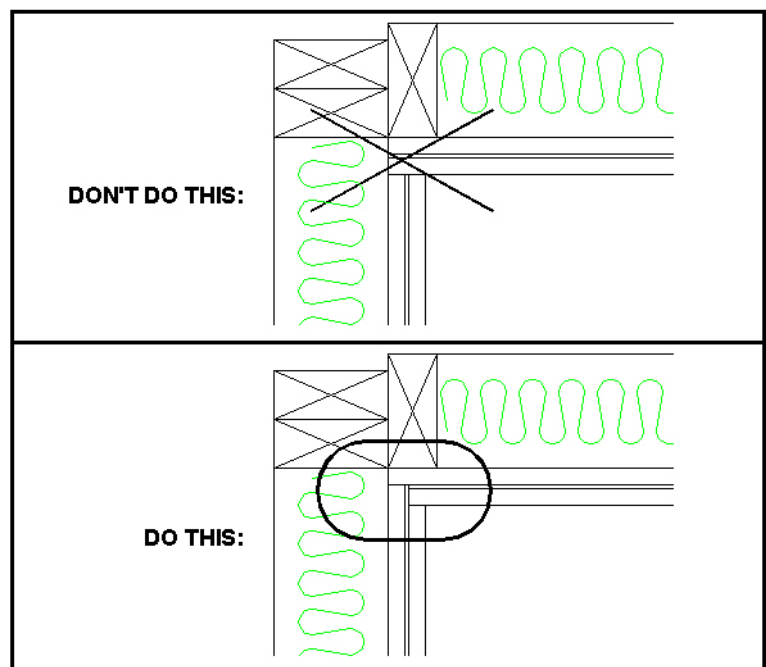

Figure 5.1: Method to properly overlap construction layers in corners

appropriate.

The customer originally thought he wanted to purchase *Venus Bass Traps* and *12" CornerFills* for all four (4) wall/ceiling junctures, but we recommended *LENRDs* instead because of his room's size. We advised *2" Studiofoam* for the walls instead of *4"* because the slap echo and excessive reverb dictate more coverage, not thicker foam. If the budget allowed, *4" Studiofoam* would be a welcome substitution.

MORE CONSTRUCTION TIPS

- When adding layers of building materials or *SheetBlok* to adjacent walls, put a layer on one wall, then the other, then one wall, then the other instead of putting all one wall's layers on at once then moving to the other wall. As shown in *Figure 5.1*, this gives sound waves a tougher path to snake through at the corners. Be sure to caulk (with *StopGap*) or mud all joints *before* adding the next layer.
- People often ask about using plywood in the construction of their studio. Plywood is not as wise a choice as gypsum board or MDF because the latter are considerably denser and in many cases cheaper.
- One easy way to achieve better sound isolation from neighboring spaces is to enlist the help of the people who are likely to be in those spaces when you're recording. To help alert them that you're laying down tracks, why not install a remote **ON AIR** light or some other warning system outside your studio so they can easily know when to keep their activity and/or noise level down? All it takes is a light switch in your studio, some cable and a fixture. For a few bucks you can probably gain quite a bit of extra quiet.
- Never smoke in your control room because it is bad for you and your equipment, to say nothing of the way it lowers your gear's resale value.
- Vacuum frequently, being careful to avoid static electricity.
- Cover your mixer with a clean towel when not in use.
- If you use a computer, turn it on *after* your power amps, etc., and turn it off *before* your power amps, etc. and make sure you turn your monitor (and peripherals) *off first and on last*.
- World's best and cheapest computer monitor anti-static cleaning wipes: Used fabric softener dryer sheets.
- Cheap "talkback" control room-to-studio communication tool: Wireless intercoms (available at *Radio Shack*) or a baby monitor.
- To keep your air as clean as outdoor air after a thunderstorm, check out an ionizer for your studio. People the world over have testified that not only do ionizers clean the air, they tend to make people feel better. They are great for allergies and getting rid of particulate matter in the air.
- Be sure to check out these two valuable links for more great tips and information:
 - [Auralex General Acoustics FAQ Page](#)
 - Monthly *Acoustology* archives (scroll down on the [Auralex Literature Page](#))

PERSONALIZED ROOM ANALYSIS FORM

If after reading Acoustics 101 you are dazed and confused, feel free to fill out our *Personalized Room Analysis Form* (Adobe Acrobat PDF), available [here](#) or from your favorite dealer. [E-mail](#) or fax it back to us and our product application specialists will respond (generally within 2-3 business days) with their suggestions for your room.

If you would prefer a quick, online analysis, rectangular rooms up to about 20'x20'x10' can be run through our [Interactive Kit Calculator](#), which will respond with a basic analysis and some suggestions for [Roominators Kits](#).

APPENDIX 1

LINKS

We have compiled many great links on acoustics here. If you have some you'd like to share, feel free to [contact us!](#)

Online Forums

- Auralex forum on [Recording.org](#)
- Auralex forum [AV:Talk](#)
- Acoustics discussion on [Studiotips.com](#)

Professional Organizations

- [Acoustical Society of America \(ASA\)](#)
- [Audio Engineering Society \(AES\)](#)
- [Custom Electronic Design and Installation Association \(CEDIA\)](#)
- [International Communications Industries Association \(InfoCOMM\)](#)
- [Institute for Noise Control Engineering \(INCE\)](#)
- [International Music Products Association \(NAMM\)](#)
- [National Systems Contractors Association \(NSCA\)](#)
- [Percussive Arts Society \(PASIC\)](#)
- [Synergetic Audio Concepts \(Syn-Aud-Con\)](#)

Professional Design Assistance

- [Russ Berger Design Group](#)
- [National Council of Acoustical Consultants \(NCAC\)](#)
- Consultants page on [Acoustics.org](#)

Acoustical Prediction, Test and Measurement

- CARA software for small room modeling from [Rhintek](#)
- ULYSSES software for large room modeling from [IFBSoft](#)
- *Audio Toolbox™* from [TerraSonde](#)
- *ETF* software from [AcustiSoft](#)

Cool Corporate (non-Auralex) Stuff

- *The British Broadcasting Company (BBC)* now has many of their acoustical research papers available for download from the [BBC R&D page](#).
- [Genelec white papers](#)
- [Rane Library](#) includes an excellent online audio dictionary, the [Pro Audio Reference](#)
- [Rosebrand](#) is the company we turn to for our heavy curtain needs.

- [Sound Construction and Supply](#) is *the* place to go for *Iso-Box™*, as well as all of your studio furniture needs.

Cool People

- Eric Desart, one of the world's best acoustical minds, has created and assembled some wonderful tools available for limited download from his [Acoustics-Noise.com](#) website.
- [Bob Golds](#) has assembled and discussed the absorption coefficients of a bunch of different materials.
- [David Griesinger](#) of *Lexicon* fame has his own technical website – very cool stuff.
- [Worshiptech.com](#) is Kent Morris' site. Kent is a world-renowned expert in church systems integration.
- Bruce Richardson has written a review of *Auralex* products and services for ProRec.com [here](#).
- Keith Yates is a leading home theater design expert. Of particular interest are [Keith's articles](#) on myriad home theater sound topics.

Other Cool Stuff

- [Some cool standing wave/mode animations](#)
- [The Gypsum Board Construction Handbook](#) is a must-have for anyone building a studio...and now it's available free electronically!

APPENDIX 2
THE ACOUSTICS 101 ROOM

"Acoustics 101" Control Room Example

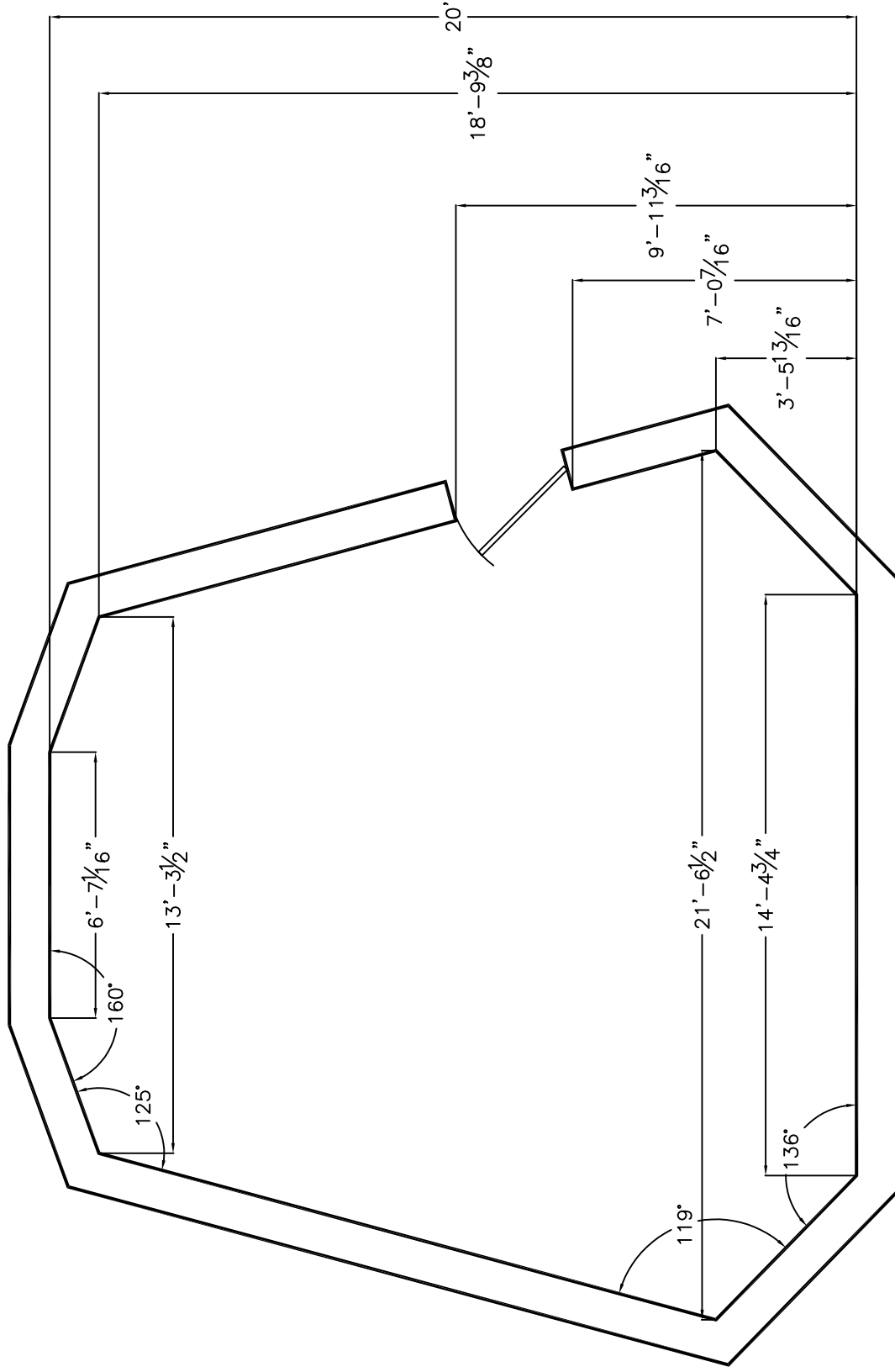

"Acoustics 101" Control Room Example

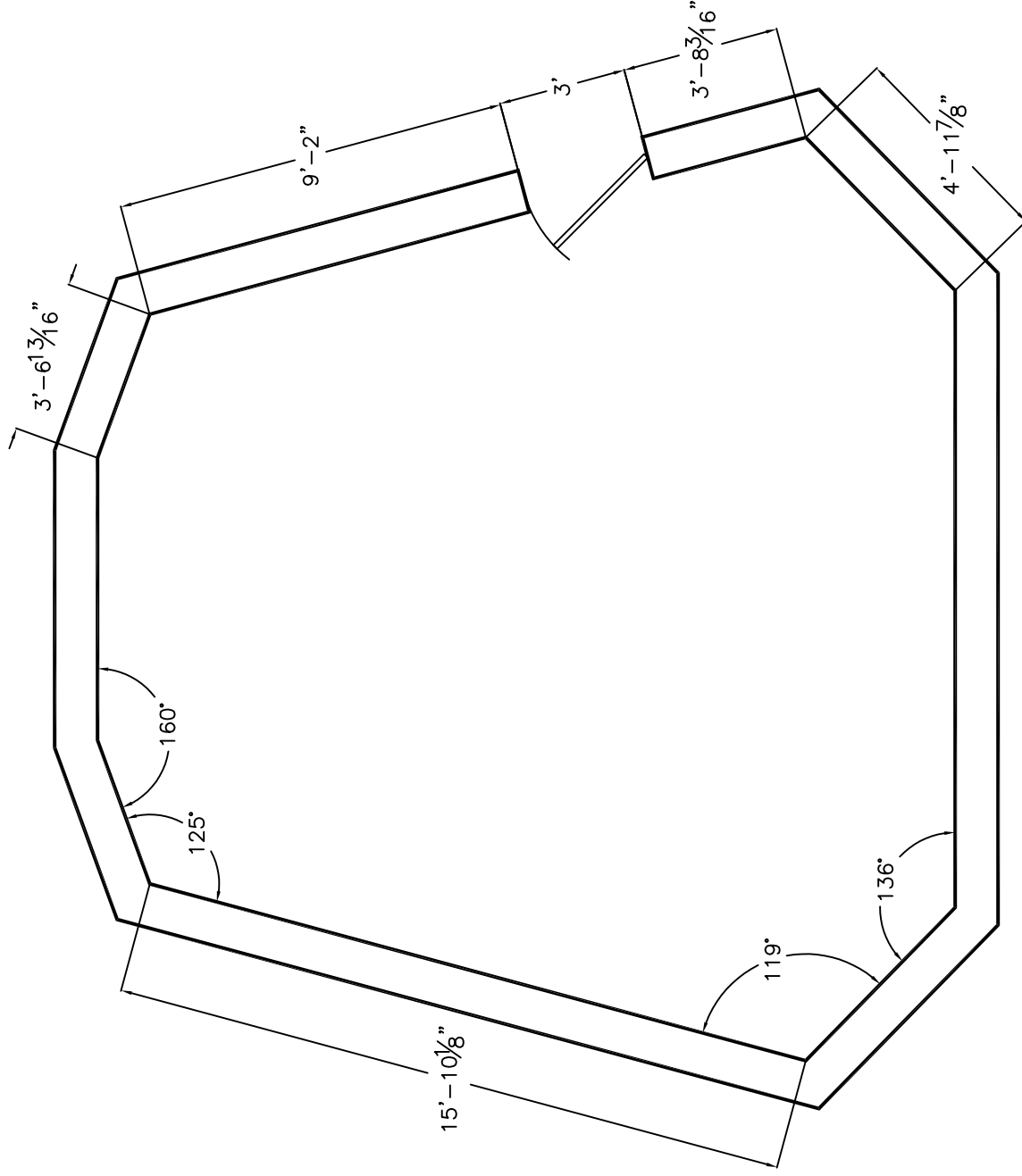

"Acoustics 101" Control Room Example

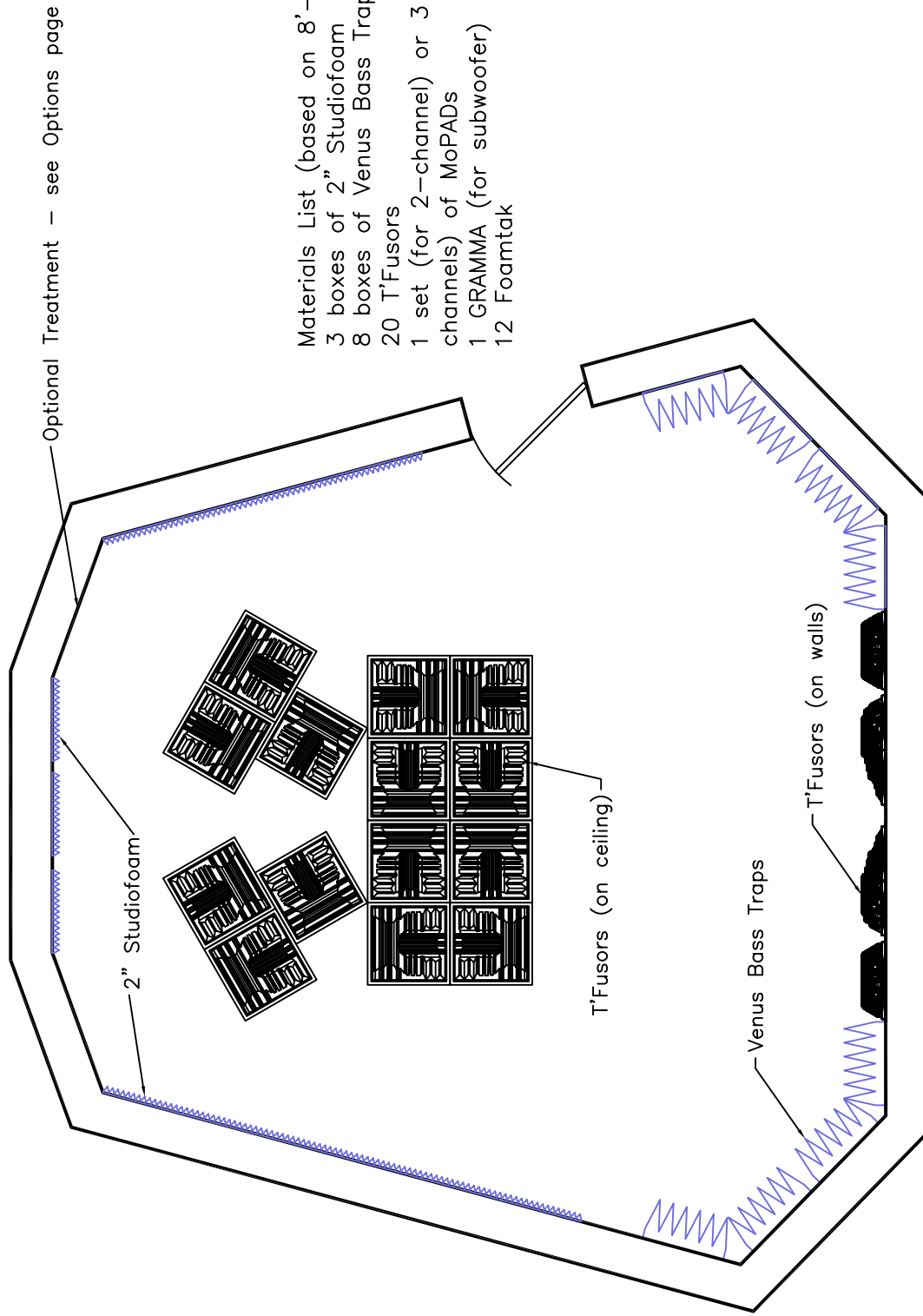

- Materials List (based on 8'-10' ceiling height):
- 3 boxes of 2" Studiofoam
 - 8 boxes of Venus Bass Traps
 - 20 T'Fusors
 - 1 set (for 2-channel) or 3 sets (for 5-6 channels) of MoPADs
 - 1 GRAMMA (for subwoofer)
 - 12 Foamtak



Plan View with Treatments

Scale: 1/4" = 1'

"Acoustics 101" Control Room Example

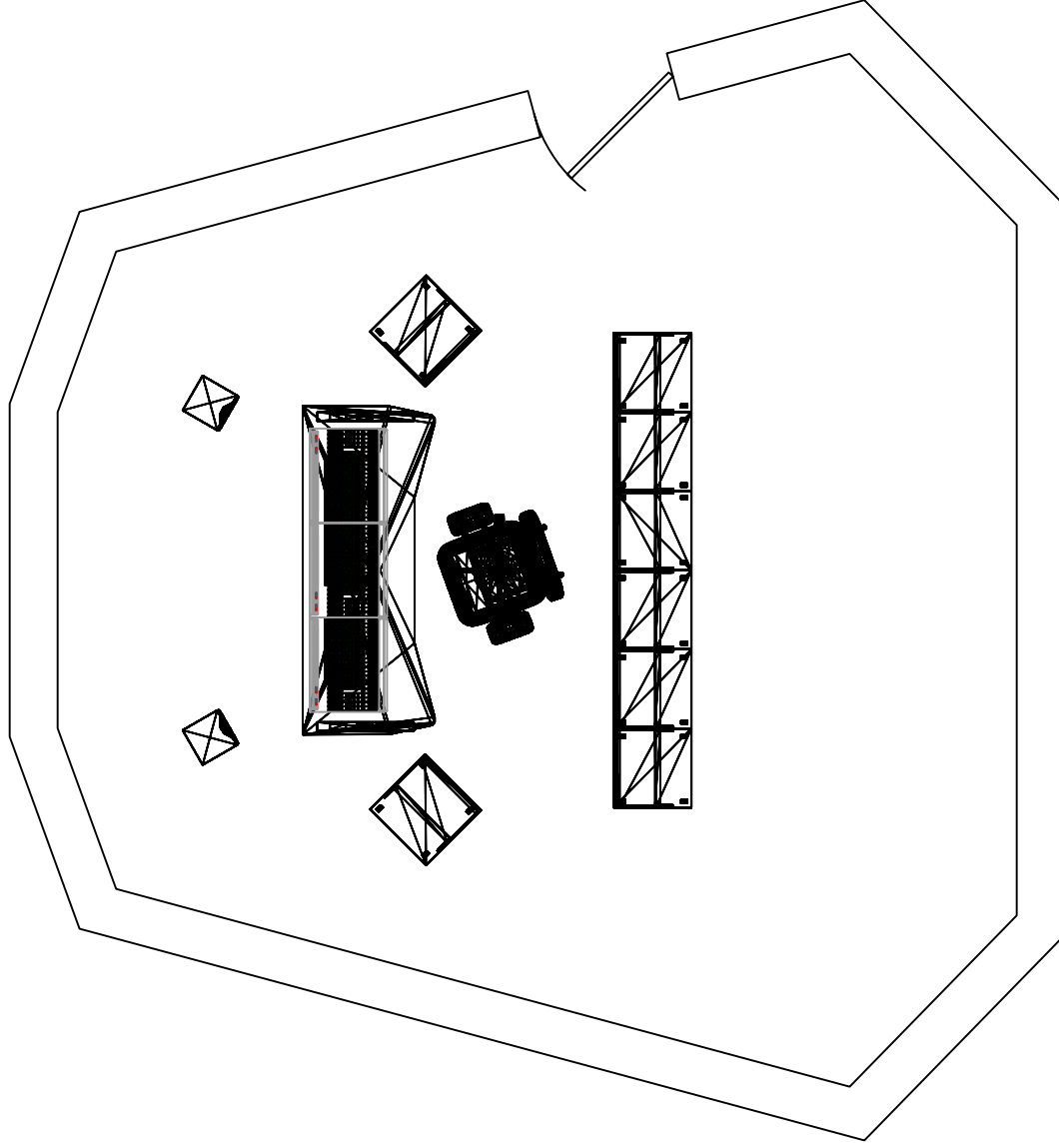

Plan View with Gear Setup
(see also: Numbered Notes and Options on Page 5)

Scale: 1/4" = 1'



"Acoustics 101" Control Room Example

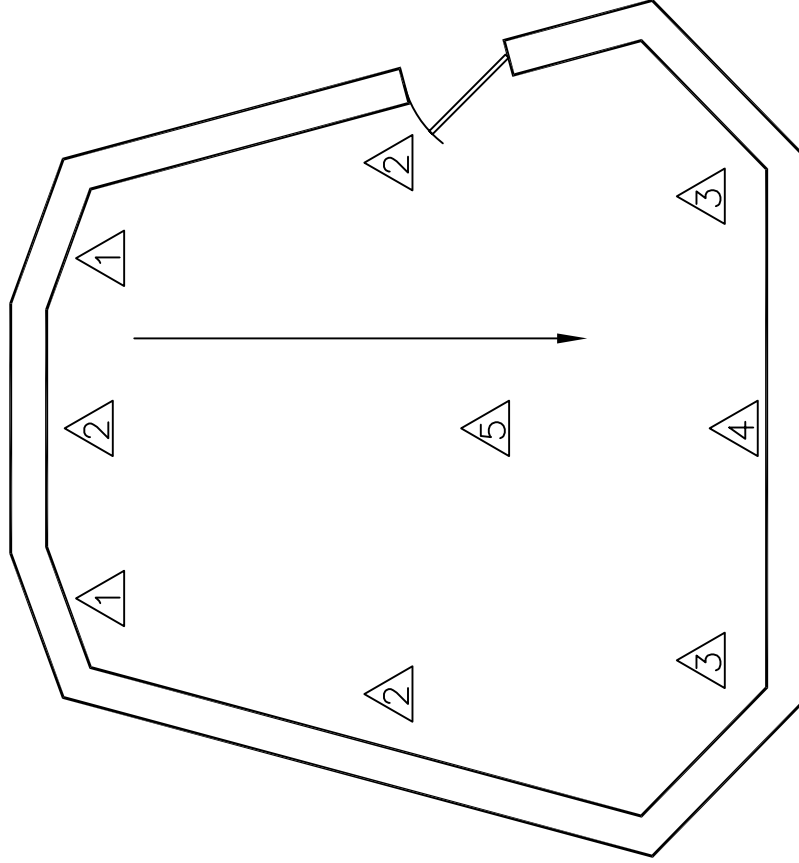

Number Notes:

- 1 – For built-in loudspeakers, do not treat. Otherwise use 2" Studiofoam to treat surfaces.
- 2 – Treatment centered at ear level. Leave 12" to 24" gap at floor. Generally, treatments extend to ceiling.
- 3 – Bass traps should be used in these areas; preferably ceiling to floor.
- 4 – Diffusion should be used on the rear wall with a random pattern centered roughly at ear level.
- 5 – Minimum ceiling height is 7'6". An 8' to 10' ceiling is strongly encouraged. A 10' or higher ceiling is also acceptable. Sloped ceilings are fine with the slope following the arrow shown (low to high).

Options:

- Floor should be hard. Tile, hardwood, laminate, etc.
- Ceiling can be an acoustical grid. A 12" space (minimum) above the grid is suggested, loosely filled with insulation. T'Fusors can be used above the mix area, dropped directly into the grid.
- Surface mount lighting fixtures are strongly encouraged. (I.e., not recessed.) If dimmers are to be used, they should be on an isolated circuit and located in a different room.
- Suggested gear placement is applicable regardless of placement of loudspeakers. (The mix location has been optimized to be in the "Reflection-Free Zone(tm)."
- Please contact Auralex with any other questions.

